

# BEYOND EINSTEIN:

from the big bang to black holes

what  
powered  
the  
big  
bang?



what  
happens  
at the  
edge of a  
black hole?

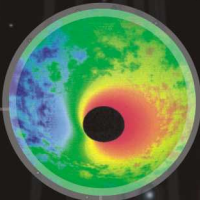

what  
is dark  
energy?

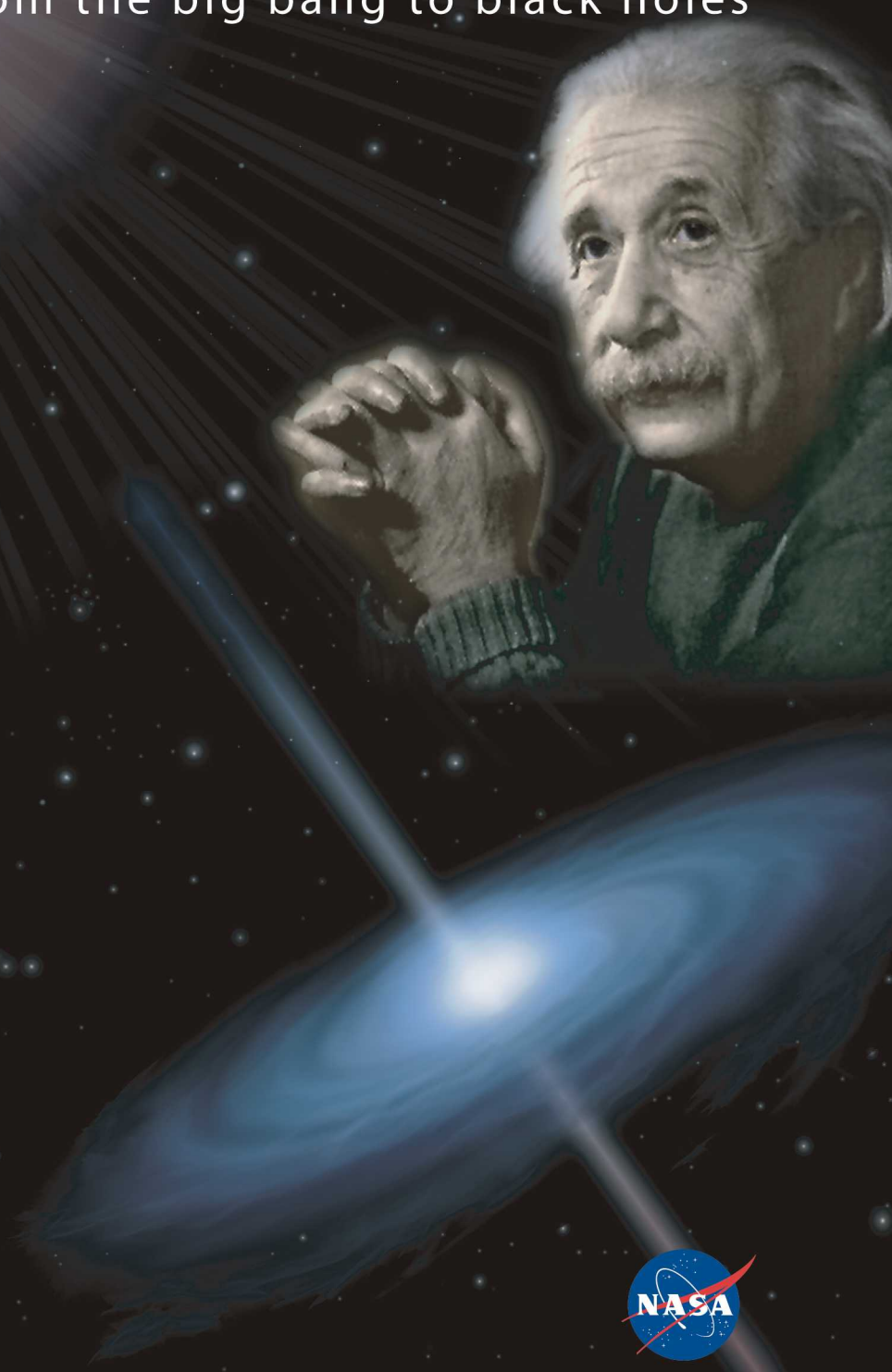



The discoveries of Albert Einstein sparked the scientific revolution of the 20th century and rank among humanity's greatest achievements. Recent developments show that we can now complete Einstein's legacy, and in the first decades of the 21st century unravel the mysteries of the Universe that await us ...

# BEYOND EINSTEIN: from the Big Bang to Black Holes

*prepared by*

The Structure and Evolution of the Universe  
Roadmap Team



Einstein images are used by permission of Roger Richman Agency representing Hebrew University and the Albert Einstein estate. Image of Einstein riding bicycle (pg. 91) courtesy of the Archives, California Institute of Technology.

*Time* magazine cover (pg. 21). *Time* is a trademark of AOL-Time-Warner, Inc., which has no connection to the NASA program.

Photo of Richard Feynman (pg. 13) by Floyd Clark/Courtesy of Caltech Archives.

Einstein letter to Georges Lemaître (pg. 13). Permission to quote granted by the Albert Einstein Archives, the Hebrew University of Jerusalem, as well as by the Einstein Papers Project.

## Preface

At the beginning of time, the Universe was formless energy. This energy transformed into the richly complex matter of which we and all we touch are made. The Structure and Evolution of the Universe (SEU) theme within NASA's Office of Space Science seeks to explore and understand the dynamic transformations of energy in the Universe—the entire web of biological and physical interactions that determine the evolution of our cosmic habitat. This search for understanding will enrich the human spirit and inspire a new generation of explorers, scientists, and engineers.

This roadmap is about the future of the SEU theme. Many science objectives encompassed by the SEU theme have been given high priority by the science community through working groups, roadmap teams, and strategic planning processes. This roadmap draws upon broad community input, including the specific recommendations of recent consensus reports of the National Academy of Sciences such as *Astronomy and Astrophysics in the New Millennium* (2001) and *Connecting Quarks with the Cosmos* (2002).

Many of the community's science priorities could be realized within the next 25 years. This roadmap recognizes that, within the resources available, not all of these science objectives can be undertaken immediately. Constructing a roadmap clearly entails making hard choices.

In this roadmap, the science objectives for SEU are presented and prioritized. The research programs and space missions required to address the science objectives are identified. The roadmap lays out a path that begins at the completion of the present program and leads to the future.

The SEU theme's highest priorities are presented in the Beyond Einstein program (Part I). A roadmap is presented for realizing these objectives starting now. The science objectives described in the Cycles of Matter and Energy program (Part II) are presented with the understanding that this program will be undertaken after Beyond Einstein has begun. Part III details continuing activities vital to maintaining the technical base to implement these missions and develop future ones.

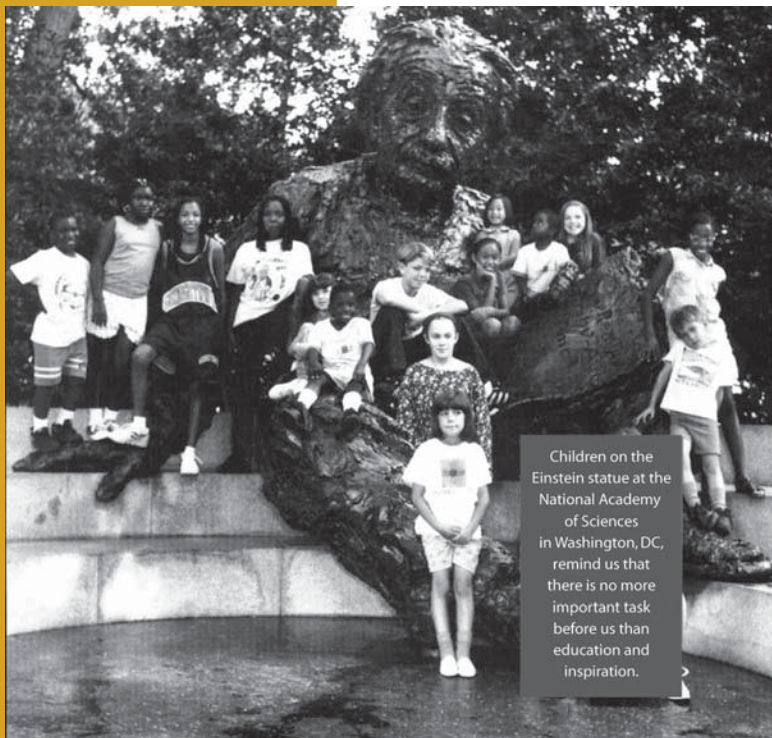

Children on the Einstein statue at the National Academy of Sciences in Washington, DC, remind us that there is no more important task before us than education and inspiration.

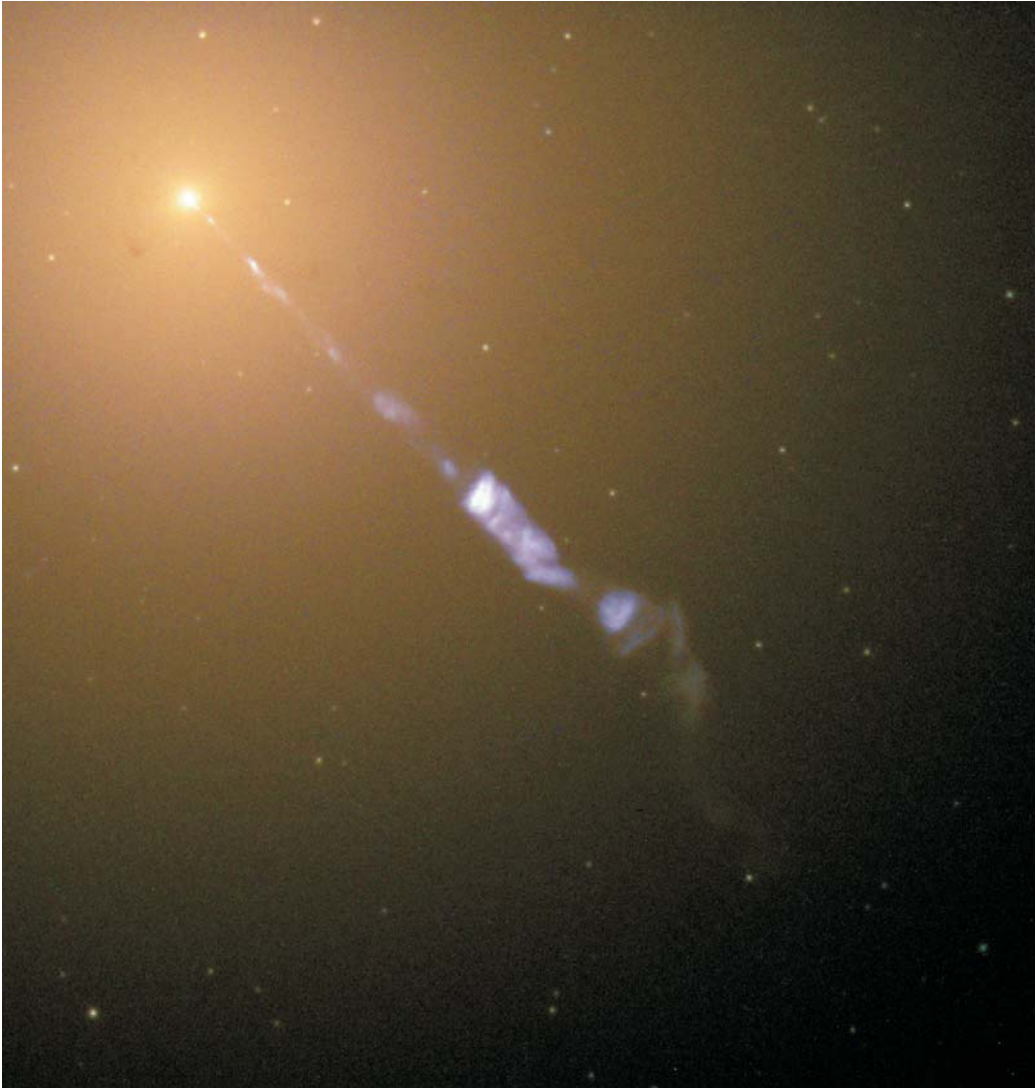

Hubble Space Telescope image of the jet of plasma moving at relativistic speed away from the supermassive black hole at the center of the nearby galaxy Messier 87.

## From the Big Bang to Black Holes

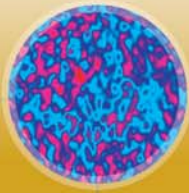

big bang

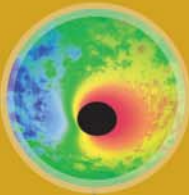

black holes



dark energy



laser  
interferometer  
space antenna



constellation-x



einstein probes

How did the Universe begin? Does time have a beginning and an end? Does space have edges? Einstein's theory of relativity replies to these ancient questions with three startling predictions: that the Universe is expanding from a **Big Bang**; that **black holes** so distort space and time that time stops at their edges; and that a **dark energy** could be pulling space apart, sending galaxies forever beyond the edge of the visible Universe. Observations confirm these remarkable predictions, the last finding only four years ago. Yet Einstein's legacy is incomplete. His theory raises—but cannot answer—three profound questions:

- What powered the Big Bang?
- What happens to space, time, and matter at the edge of a black hole?
- What is the mysterious dark energy pulling the Universe apart?

The *Beyond Einstein* program aims to answer these questions. It will employ a series of missions linked by powerful new technologies and complementary approaches to shared science goals.

### Einstein Great Observatories: Facility-class missions

- Constellation-X: Uses X-ray-emitting atoms as clocks to follow matter falling into black holes and to study the evolution of the Universe.
- The Laser Interferometer Space Antenna (LISA): Uses gravitational waves to sense directly the changes in space and time around black holes and to measure the structure of the Universe.

These missions are ready to pioneer technologies and approaches needed for the Vision Missions to reach the ends of space and time.

### Einstein Probes: Fully competed, moderate-sized, scientist-led missions launched every three years

- Dark Energy Probe: Determine the properties of the dark energy that dominates the Universe.
- Inflation Probe: Detect the imprints left by quantum effects and gravitational waves at the beginning of the Big Bang.
- Black Hole Probe: Take a census of black holes in the local Universe.

These missions will answer sharply focused questions. Competition ensures flexibility and keeps costs low by selecting methods and technologies.

### Programs of technology development and research in preparation for two "Vision Missions" reaching to the ends of space and time

- A Big Bang Observer to detect directly gravitational waves echoing from the earliest moments of the Big Bang.
- A Black Hole Imager to image directly matter near the edge of a black hole and map its motion.

*Beyond Einstein* fascinates the American public and compels the attention of the news media and the entertainment industry. *Beyond Einstein* amplifies this fascination, developing an education component that enthralles students *and* is aligned with national standards. It will be a potent force with which to enhance science education and science literacy.



*Hubble (top) and Chandra X-ray Observatory (bottom) images of the galaxy NGC 6240. The X-ray image reveals light from matter falling into two supermassive black holes (blue) in the core of the galaxy. The two black holes will merge in less than a billion years. The Beyond Einstein LISA mission will measure the ripples in space and time created by such events in other galaxies.*

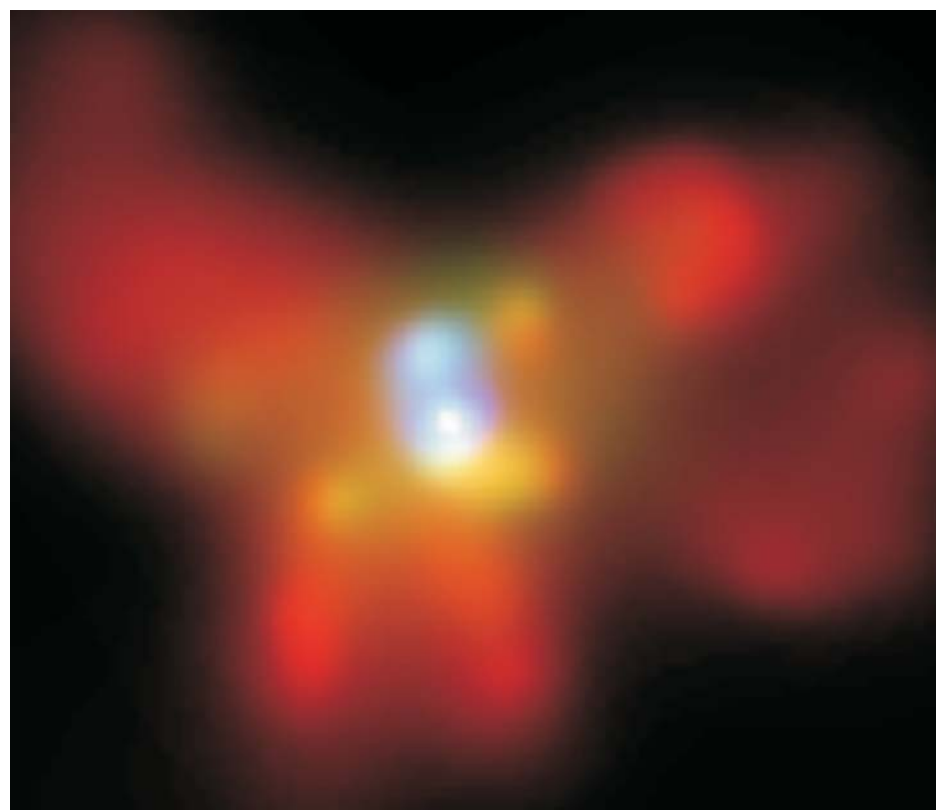



## *Contents*

Preface .....	3
From the Big Bang to Black Holes .....	5
Part I. Beyond Einstein .....	9
Beyond Einstein Science Objectives and Research Focus Areas .....	10
Chapter 1. Executive Summary .....	11
The Beyond Einstein Program .....	14
Chapter 2. Scientific Goals and Missions .....	21
Beyond Einstein: The Science .....	21
Beyond Einstein: The Program .....	31
Beyond Einstein: The Missions .....	35
Chapter 3. Technology Roadmap: Beyond Einstein .....	47
Einstein Great Observatory Technologies .....	47
Technology Development for the Einstein Probes .....	49
Technologies for Beyond Einstein Vision Missions .....	51
Chapter 4. Research and Analysis .....	55
Theory .....	55
Supporting Ground-Based Research and Analysis .....	56
Chapter 5. Education and Public Outreach .....	57
Education, Outreach, and the Public Mandate .....	57
Part II. Cycles of Matter and Energy .....	61
Cycles Science Objectives and Research Focus Areas .....	62
Chapter 6. Science Objectives .....	63
A Rich and Diverse Universe .....	63
What We Have Learned .....	65
The Next Steps: The Space Astronomy Imperative .....	66
Chapter 7. Technology Roadmap: Cycles of Matter and Energy	79
Large, Lightweight Optics .....	79
Detectors .....	79
Spacecraft Systems .....	81
Part III. Supporting the Roadmap .....	83
Chapter 8. The Explorer Program .....	85

Chapter 9. Research and Analysis .....	87
Experimental Research: Creating the Tools of Investigation .....	87
Theory, Observations, and Data Analysis: Reaping the Benefits of Investment .....	89
Chapter 10. External Factors .....	91
Last Word .....	93
Appendix A. Mapping of Science Objectives and Research Focus Areas to Investigations .....	95
Appendix B. Acronyms .....	99
Appendix C. Glossary of Terms .....	101
Appendix D. Sources of Further Information.....	105
Appendix E. Contributors to the Roadmap .....	107

# **Part I**

## **Beyond Einstein**

*Beyond Einstein* is a bold attack on the deepest mysteries of nature. The program will study the building blocks of our own existence at the most basic level: the matter, energy, space, and time that create the living Universe. *Beyond Einstein* missions will extend the reach of humanity to the ultimate extremes: the birth of the Universe, the edges of space and time near black holes, and the darkest spaces between the galaxies. Together these studies will help us understand how the matter and energy of the Universe come to life.

*Beyond Einstein* missions will connect humans to the vast Universe far beyond the Solar System, to the entirety of creation. They will extend our senses beyond what we can imagine today: to the largest and smallest things, the beginnings and ends of time and space. The images and knowledge gained in this quest will inspire all humanity—as only NASA can.

## ***Beyond Einstein* Science Objectives and Research Focus Areas.**

*NASA Agency Goal: Explore the Solar System and the Universe beyond.*

### **Science Objective 1. Find out what powered the Big Bang.**

Research Focus Area 1. Search for gravitational waves from inflation and phase transitions in the Big Bang.

Research Focus Area 2. Determine the size, shape, age, and energy content of the Universe.

### **Science Objective 2. Observe how black holes manipulate space, time, and matter.**

Research Focus Area 3. Perform a census of black holes throughout the Universe.

Research Focus Area 4. Determine how black holes are formed and how they evolve.

Research Focus Area 5. Test Einstein’s theory of gravity and map spacetime near the event horizons of black holes and throughout the Universe.

Research Focus area 6. Observe stars and gas plunging into black holes.

### **Science Objective 3. Identify the mysterious dark energy pulling the Universe apart.**

Research Focus Area 2. Determine the size, shape, age, and energy content of the Universe.

Research Focus Area 7. Determine the cosmic evolution of the dark energy.

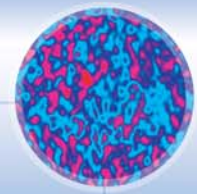

big bang

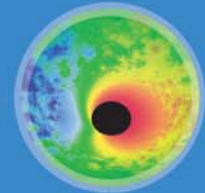

black holes



dark energy

*“Gravity is the force that rules the Universe. To understand its workings, to the finest degree, is to understand the very nature of our celestial home.”*  
—M. Bartusiak in *Einstein’s Unfinished Symphony*

## Chapter 1. Executive Summary

How did the Universe begin? Does time have a beginning and an end? Does space have edges? The questions are clear and simple. They are as old as human curiosity. But the answers have always seemed beyond the reach of science. Until now.

In their attempts to understand how space, time, and matter are connected, Einstein and his successors made three predictions. First, space is expanding from a Big Bang; second, space and time can tie themselves into contorted knots called “black holes” where time actually comes to a halt; third, space itself contains some kind of energy that is pulling the Universe apart. Each of these three predictions seemed so fantastic when it was made that everyone, including Einstein himself, regarded them as unlikely. Incredibly, all three have turned out to be true. Yet Einstein’s legacy is one of deep mystery, because his theory is silent on three questions raised by his fantastic predictions: (1) What powered the Big Bang? (2) What happens to space, time, and matter at the edge of a black hole? (3) What is the mysterious dark energy pulling the Universe apart?

To find answers, we must venture beyond Einstein. The answers require new theories, such as the inflationary universe and new insights in high-energy particle theory. Like Einstein’s theory, these make fantastic predictions that seem hard to believe: new unseen dimensions and entire universes beyond our own. We must find facts to confront and guide these new theories. Powerful new technologies now make this possible.

Here is where the *Beyond Einstein* story starts. By exploring the three questions that are Einstein’s legacy, we begin the next revolution in understanding our Universe. We chart our way forward using clues from observations and from new ideas connecting the worlds of the very small and the very large.

### *What powered the Big Bang?*

During the last decade, sky maps of the radiation relic of the Big Bang—first by NASA’s Cosmic Background Explorer (COBE) satellite and more recently by other experiments, including Antarctic balloon flights and NASA’s Microwave Anisotropy Probe (MAP)—have displayed the wrinkles imprinted on the Universe in its first moments. Gravity has pulled these wrinkles into the lumpy Universe of galaxies and planets we see today. Yet

The MAP Explorer mission provides the clearest view yet of the cosmic microwave background, using the wrinkles imprinted upon it from the earliest moments of the big bang to provide precision measurements on the expansion and contents of the Universe.

### *MAP Simulation*

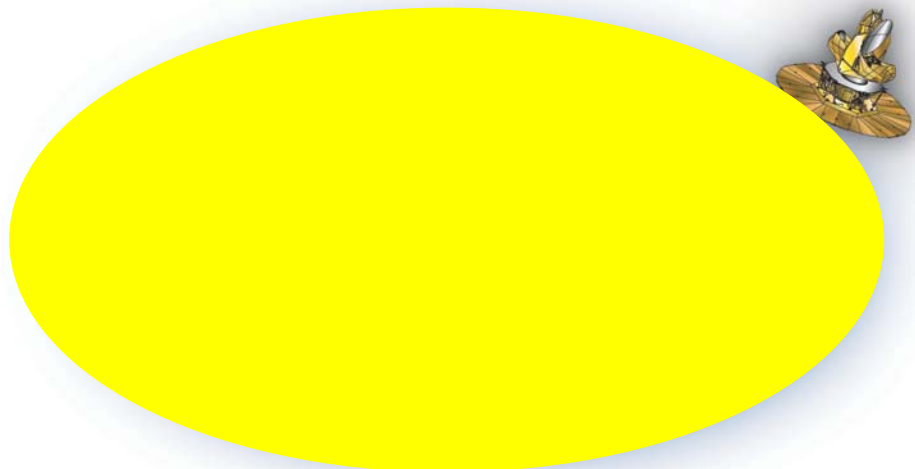

Simulation of the map of the cosmic microwave background that is being obtained by NASA’s Microwave Anisotropy Probe (MAP).

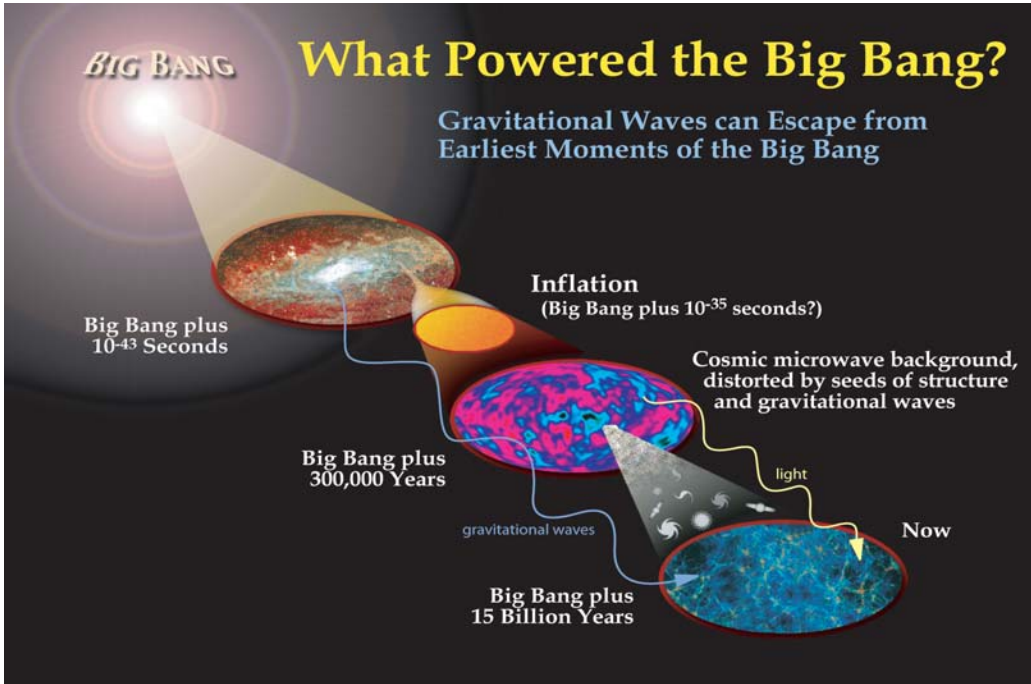

Quantum fluctuations during the Big Bang are imprinted in gravitational waves, the cosmic microwave background, and in the structure of today's Universe. Studying the Big Bang means detecting those imprints.

still unanswered are the questions: why was the Universe so smooth before, and what made the tiny but all-important wrinkles in the first place?

Einstein's theories led to the Big Bang model, but they are silent on these questions as well as the simplest: "What powered the Big Bang?" Modern theoretical ideas that try to answer these questions predict that the wrinkles COBE discovered arose from two kinds of primordial particles: of the energy field that powered the Big Bang; and gravitons, fundamental particles of space and time.

Measurements by missions of the *Beyond Einstein* program could separate these different contributions, allowing us to piece together the story of how time, space, and energy worked together to power the Big Bang.

***What happens to space, time, and matter at the edge of a black hole?***

The greatest extremes of gravity in the Universe today are the black holes formed at the centers of galaxies and by the collapse of stars. These invisible bodies can be studied by examining matter swirling into them, and by listening to the waves of distortion they make in spacetime. New data from X-ray satellites, such as NASA's Chandra X-ray Observatory and ESA's XMM-Newton, show signs of gas whizzing about black holes at close to the speed of light and hint that time is slowing as the gas plunges into the zone from which

Most of the X-ray sources seen in this 12-day exposure by the Chandra X-ray Observatory are active galaxies and quasars powered by massive black holes. Ground-based observations show that many of them are shrouded by dust; many others remain unidentified, invisible except in X-rays.

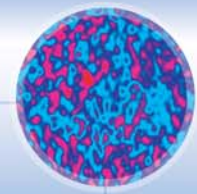

big bang

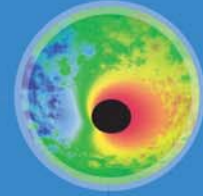

black holes



dark energy

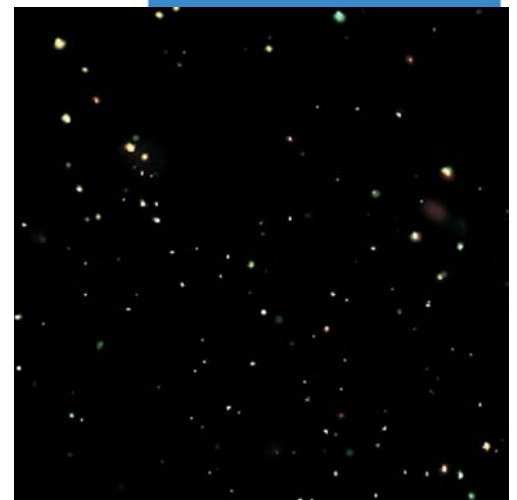

*“In modern physics, the vacuum is simply the lowest energy state of the system. It need not be empty nor uninteresting, and its energy is not necessarily zero.”*

—From *Quarks to Cosmos*,  
Report of the  
Committee on the  
Physics of the  
Universe

Richard Feynman [Nobel Prize, 1965] showed that “empty” space was filled with virtual particles.

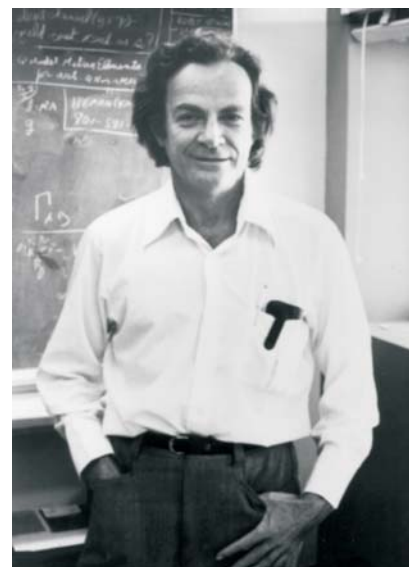

escape is impossible. *Beyond Einstein* missions will take a census of black holes in the Universe and give detailed pictures of what happens to space and time at the edges of these roiling vortices.

*Beyond Einstein* missions will listen to the sounds of spacetime carried by a new form of energy, predicted by Einstein, called gravitational waves. We will hear the booming, hissing, and humming of colliding and merging black holes and other extreme flows of matter throughout the Universe. These sounds will detail the conversion of matter and energy into warps in space and time. The measurements of gravitational waves will provide a new way of understanding the behavior of space and time near black holes and take us beyond to a new understanding of spacetime singularities.

Einstein himself never dreamed that it would be possible to detect these waves, which only vary the distance between objects as far apart as the Earth and Moon by less than the width of an atom. Yet the technology now exists to do so.

### ***What is the mysterious dark energy pulling the Universe apart?***

A landmark discovery of the 1990s was that the expansion of the Universe is accelerating. The source of this mysterious force opposing gravity we call “dark energy.”

Because he originally thought the Universe was static, Einstein conjectured that even the emptiest possible space, devoid of matter and radiation, might still have a dark energy, which he called a “Cosmological Constant.” When Edwin Hubble discovered the expansion of the Universe, Einstein rejected his own idea, calling it his greatest blunder.

As Richard Feynman and others developed the quantum theory of matter, they realized that “empty space” was full of temporary (“virtual”) particles continually forming and destroying themselves. Physicists began to suspect that indeed the vacuum ought to have a dark form of energy, but they could not predict its magnitude.

Through recent measurements of the expansion of the Universe, astronomers have discovered that Einstein’s “blunder” was not a blunder: some form of dark energy does indeed appear to dominate the total mass-energy content of the Universe, and its weird repulsive gravity is pulling the Universe apart.

“I found it very ugly indeed that the field law of gravitation should be composed of two logically independent terms which are connected by addition. About the justification of such feelings concerning logical simplicity it is difficult to argue. I cannot help to feel it strongly and I am unable to believe that such an ugly thing should be realized in nature.”

—*Albert Einstein*, in a Sept. 26, 1947, letter to Georges Lemaître



We still do not know whether or how the highly accelerated expansion in the early Universe (inflation) and the current accelerated expansion (due to dark energy) are related.

A *Beyond Einstein* mission will measure the expansion accurately enough to learn whether this energy is a constant property of empty space (as Einstein conjectured), or whether it shows signs of the richer structure that is possible in modern unified theories of the forces of nature.

## The Beyond Einstein Program

The *Beyond Einstein* program has three linked elements which advance science and technology towards two visions: to detect directly gravitational wave signals from the earliest possible moments of the Big Bang, and to image the event horizon of a black hole. The central element is a pair of Einstein Great Observatories, Constellation-X and LISA. These powerful facilities will blaze new paths to the questions about black holes, the Big Bang, and dark energy. They will also address other central goals of contemporary astrophysics (discussed in Part II of this roadmap). The second element is a series of competitively selected Einstein probes, each focused on one of the science questions. The third element is a program of technology development, theoretical studies, and education, to support the Probes and the vision missions: the Big Bang Observer and the Black Hole Imager. The program offers competitive opportunities for mission leadership, technology development, and groundbreaking scientific research, with goals that excite the public.

### *Einstein Great Observatories*

While these two missions are focused on specific observational goals, the capabilities they provide are so dramatically new that they will also provide a broad science return that will impact all areas of astrophysics, as have Hubble Space Telescope and the Chandra X-ray Observatory before them.

**The Laser Interferometer Space Antenna (LISA)** will deploy three spacecraft orbiting the Sun, separated from each other by five million kilometers (17 light seconds). Each spacecraft will contain freely falling “proof masses” protected from all forces other than gravity. The relative motion of the masses can be measured to sub-nanometer accuracy by combining laser beams shining between the spacecraft. Passing gravitational waves will ripple space and time, revealing their presence by altering the motion of the proof masses.

LISA will probe space and time at the forming edges of black holes by listening to the sounds of vibrating spacetime: the booming roar of supermassive black holes merging, the chorus of death cries from stars on close orbits around black holes, and the ripping noise of zipping singularities. It may even hear whispers from the time in the early Universe when our three-dimensional space formed within the now unseen space of six or seven dimensions. LISA will plot the orbits of stars around black holes to test Einstein’s theory under extreme conditions.

LISA measurements of merging black holes will provide a new yardstick with which to mea-

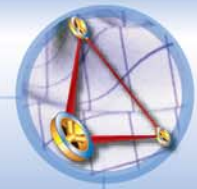

laser  
interferometer  
space antenna



constellation-x

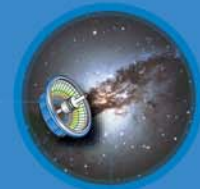

einstein probes

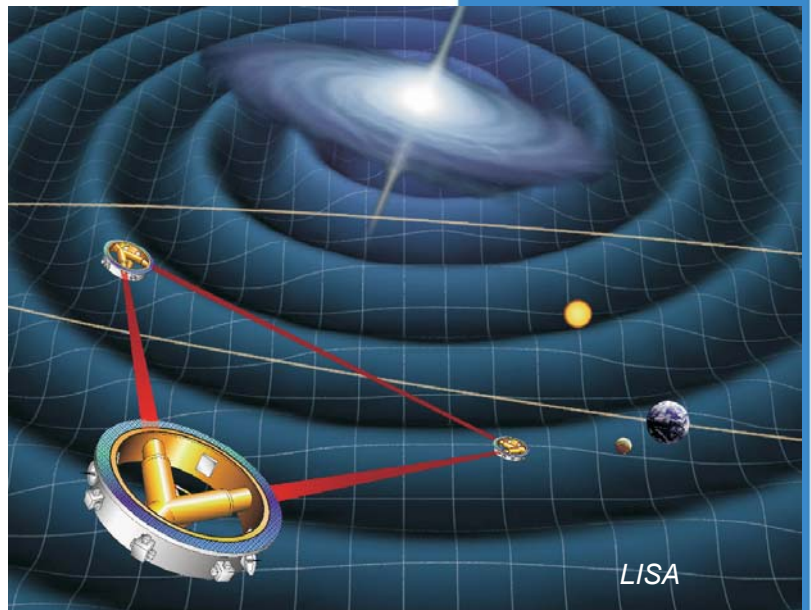



sure the Universe and constrain the nature of dark energy. LISA will also measure waves from black holes in the first structures of the Universe to collapse. It will measure gravitational waves from thousands of binary star systems in our Galaxy, yielding new insights into the formation and evolution of binary stars.

**The Constellation-X mission** will consist of four 1.6-meter X-ray telescopes orbiting the Earth/Sun system, providing nearly 100 times the sensitivity of the Chandra X-ray Observatory and other planned missions for X-ray spectroscopy. They will be instrumented to cover a range of more than a factor of 100 in X-ray energy with unprecedented energy resolution.

Constellation-X will address the question, “What happens to matter at the edge of a black hole?” When plasma streams collide at nearly the speed of light, they become hot enough to emit X rays. The vibrations of the X-ray light act as clocks that we can use to

track the motions of the plasma and the distortions of space and time near the black hole. The great sensitivity of Constellation-X will allow us to make “slow-motion movies” of the gas at a high frame rate. Current instruments are not sensitive enough for the short exposures needed to freeze the motion.

Constellation-X will dramatically increase our ability to obtain high resolution X-ray spectroscopy of faint X-ray sources. This will enable us to constrain the nature of dark matter and dark energy by observing their effects on the formation of clusters of galaxies. These measurements, and those by the Dark Energy Probe, LISA, and the Inflation Probe, will each constrain different possible properties of dark energy and together lead to its understanding. Constellation-X’s high resolution spectra will provide fresh diagnostics of the speed, density, temperature, and composition of plasma in galaxies and

exotic stars throughout the Universe, allowing new studies of their nature and evolution.

Black holes grow both by accreting gas and by accreting stars. They change both by ejecting gas and by merging with other black holes. To understand the origin and nature of the giant black holes in the centers of galaxies requires both LISA and Constellation-X, working together to cover all four of these processes.

### *Einstein Probes*

Complementing the facility-class Einstein Great Observatories, a series of sharply focused missions will address those critical science goals that do not require facility-class missions. For these missions, the science question is defined strategically but the science approach and mission concept will be determined through peer review. We identify three compelling questions whose answers can take us beyond Einstein.

**“How did the Universe begin?”** Scientists believe the Universe began with a period of “inflation,” when the Universe expanded so rapidly that parts of it separated from other parts faster than the speed of light. Inflation theory predicts that this expansion was propelled by a quantum-mechanical energy of the vacuum similar to the dark energy today. It may hold the answer to the question, “What powered the Big Bang?” One way to test this

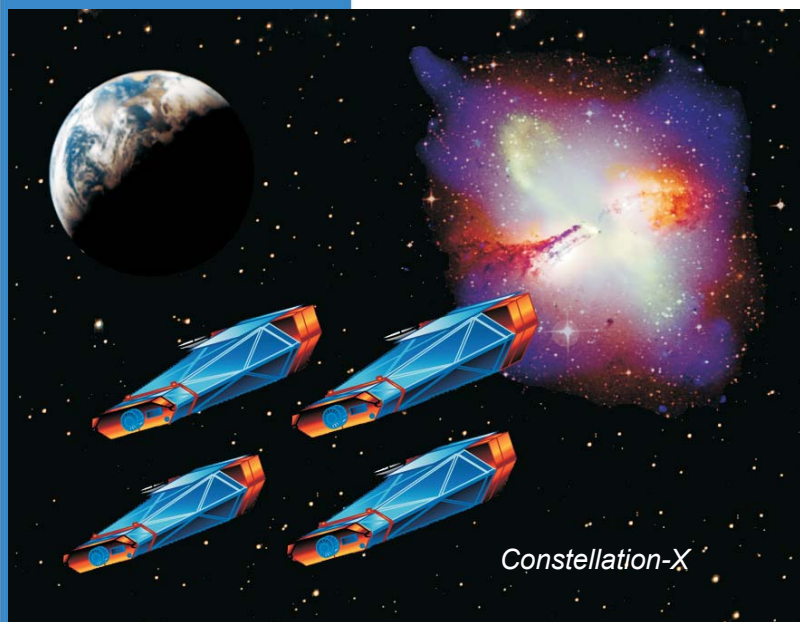

Constellation-X

Many NASA missions have laid the groundwork for the *Beyond Einstein* program, and will complement it. NASA's *COBE* discovered the first evidence for primordial density fluctuations in the CMB. NASA's balloon program (e.g., the NASA/NSF/Italian/UK *BOOMERanG*) has supported the discovery of the interaction of those fluctuations with matter in the Universe. NASA's *MAP* satellite and the ESA's planned *Planck* satellite will extend these discoveries and are vital precursors to the proposed Inflation Probe.

*The Hubble Space Telescope* has helped to find and measure the distant supernovae that have forced us to accept the reality of dark energy.

X-ray missions, including NASA's *Chandra X-ray Observatory* and *RXTE*, ESA's *XMM-Newton*, and Japan's *ASCA*, have discovered X rays from matter spiraling into black holes, illustrating the potential of Constellation-X.

**Gravity Probe B** will test one of Einstein's exotic predictions: that the rotation of the Earth drags space and time around the Earth into a mild version of the tremendous vortical spin near a spinning black hole.

*Swift* will study gamma-ray bursts, believed to be a result of the stellar explosions and mergers which create black holes. *Swift* will also test technology for the Black Hole Finder Probe.

*GLAST* will provide more sensitivity and energy coverage than ever before for the study of high-energy emissions from particles accelerated in gamma-ray bursts and in the jets from spinning black holes in galactic nuclei.

Japan/NASA's *Astro-E2* will be the first to use NASA-provided microcalorimeters that are prototypes for Constellation-X detectors.

*ST-7* and ESA's *SMART-2* will provide a flight comparison of two disturbance reduction technologies competing for use on LISA.

idea is to look for relics of quantum fluctuations. Gravitational waves are the most direct relics since they penetrate the heat and density of those early days.

It is technically feasible to look for the quantum effect of gravitational waves and distinguish them from the quantum effects of the primordial energy, by examining their distinctive effects on the polarization of the cosmic microwave background. An "Inflation Probe" with this capability will help define the nature of the vacuum that drove inflation.

**"How did black holes form and grow?"** Most astronomers believe that the black holes in the centers of galaxies grew by swallowing stars and gas, emitting light in the process. But there is an accounting problem: not enough light is coming from black holes in active galaxies to explain their growth. There are hints that much of the growth occurred behind a veil of dust. One way to see into these dark corners is to use the most penetrating of X rays. The "Black Hole Finder Probe" will perform a census of hidden black holes, revealing the demographics and life cycles of black holes and identifying black holes for study with Constellation-X. Combining these data with studies of accretion by Constellation-X and of black hole mergers by LISA will reveal how giant black holes formed.

**"What is the mysterious energy pulling the Universe apart?"** is a question that would not have been asked five years ago, before there was evidence that the Universe was being pulled apart. To understand this energy, we must measure the expansion of the Universe with high precision. This will require the most precise cosmic yardsticks we can find.

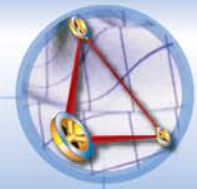

laser  
interferometer  
space antenna



constellation-x

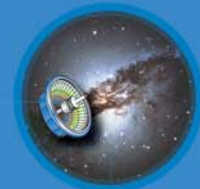

einstein probes

*Gravitational waves are vibrations in the fabric of space and time. Gravitons are their quanta. Unlike photons (the quanta of light), gravitons hardly interact at all with matter, so our senses have never before detected them. The light we see from the Big Bang, the Cosmic Microwave Background, last bounced off matter when the Universe was 300,000 years old. Gravitons from the Big Bang have been hurtling toward us unchanged since the Universe was  $10^{-35}$  seconds old!*

The dark energy filling your house has just enough energy for a flea to make one jump. Yet across the immense volume of the Universe, this energy can overcome the gravitational attraction of all the billions of galaxies.

Several ideas for such “Dark Energy Probes” have been proposed—for example, precision measurement of distant supernovae by a wide-field space telescope.

Independent diagnostics of the dark energy will be crucial to verify the validity of results and to increase the precision of the measurements. The Inflation Probe and LISA will provide completely independent cosmic yardsticks with which to measure the effects of dark energy, and Constellation-X will observe the first clusters of galaxies whose evolution depends critically on dark matter and dark energy.

**The Ultimate Vision**

The technology to go far beyond Einstein is within our reach if we approach the grand goals systematically, mission building upon mission, proving and refining the required technology. Strategic investments in hardware, software, and astrophysical theory will lead the way forward to two visions:

To explore the beginning of time, a “Big Bang Observer” will build upon LISA to directly measure gravitons from the early Universe still present today. In contrast to the Inflation Probe’s measurement of frozen imprints of much longer waves on the microwave background, the Big Bang Observer will observe gravitational waves in their origi-

**BEYOND EINSTEIN PROGRAM**

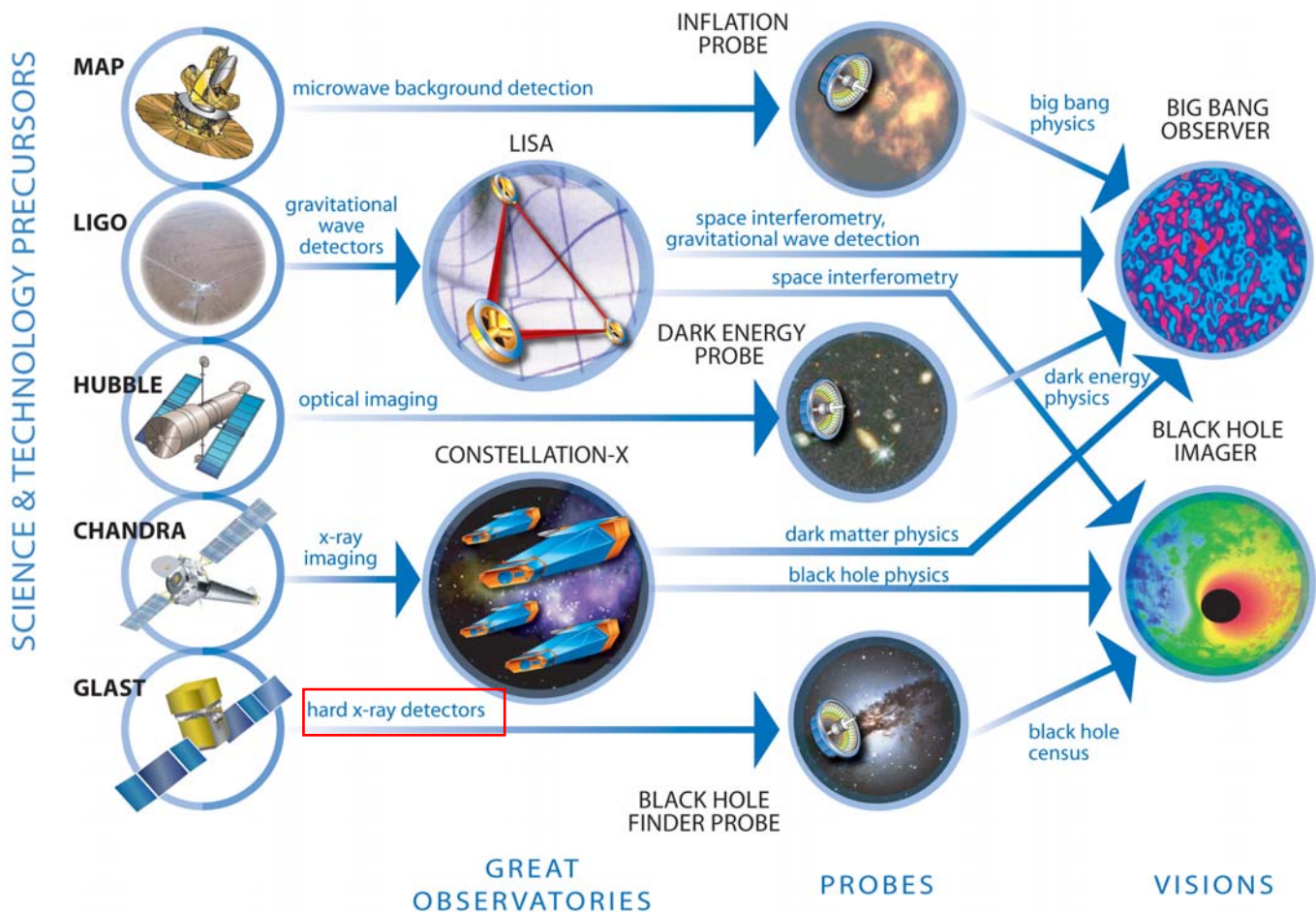

The Gamma-Ray Large Area Space Telescope (GLAST) is the highest priority mission already under development in the Structure and Evolution of the Universe theme. This roadmap assumes its completion and scheduled launch in 2006. GLAST is an international and multi-agency (NASA and DOE) project.

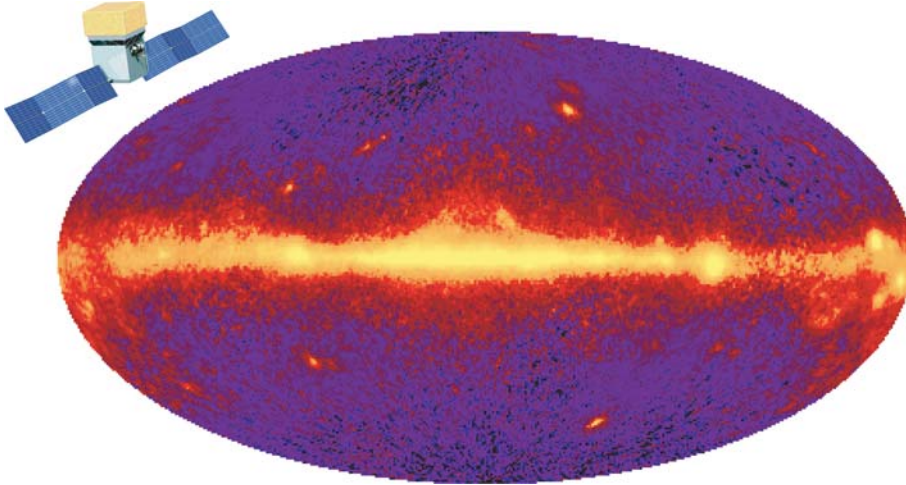

GLAST builds upon the success of the EGRET high-energy telescope on the Compton Gamma Ray Observatory. The Large Area Telescope on GLAST will map the sky in one day at the same flux level that EGRET could achieve in one year, shown in the EGRET all-sky map above.

With more than 30 times the sensitivity of EGRET and broader energy coverage, GLAST will study the processes that expel relativistic plasma and accelerate particles near the black holes believed to lurk in Active Galactic Nuclei and Gamma-Ray Bursts. It will elucidate the origin of energetic gamma-radiation from pulsars and the acceleration of cosmic rays in supernova remnants. It will help identify the many EGRET sources whose nature remains a mystery and search the Universe for gamma-ray signatures of hypothesized decaying particles of Dark Matter.

nal form, from still earlier in the Big Bang. The Big Bang Observer would give us a direct view of the creation of spacetime, a truly profound achievement.

To explore the end of time and the edges of space, Constellation-X will measure the spectral signatures of gas swirling into black holes, and LISA will record the tune to which stars dance around it. But there is no substitute for a direct image. A “Black Hole Imager” based on X-ray interferometry could take this epochal picture, revealing directly the fate of matter near a black hole.

**Technology**

While the enabling foundations are well in hand, the *Beyond Einstein* program demands many refinements in technology. Constellation-X will need lightweight optics and cryogenic X-ray calorimeters. LISA needs sensitive monitoring units coupled to micronewton thrusters to keep its test masses free of non-gravitational forces. It will also require very stable laser measurement systems. The Einstein Probes require study of a broad range of technologies so that the most effective approach to their science

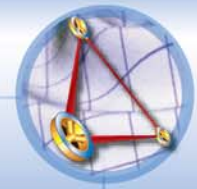

laser interferometer space antenna



constellation-x

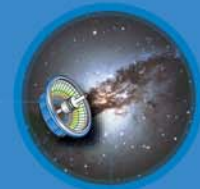

einstein probes

Public interest in the Chandra X-ray Observatory has led to more than 850 newspaper articles and wire stories in its first three years of operation—including 27 in the *NY Times*, *Washington Post*, and *USA Today*—and more than 10 newscasts, including CNN, ABC, CBS, and NPR.

goals can be chosen. The vision missions, Black Hole Imager and Big Bang Observer, need still greater precision in spacecraft pointing and control.

### Research and Analysis

The R&A program is the cradle for the technology and theory of NASA space science missions. It is the first step in a process that turns ideas into missions, as well as the final step in turning missions into scientific advances. NASA's R&A program draws heavily on the resources of our universities, providing an additional benefit: the training of students who become the architects and builders of future missions. The Einstein Probes require new detectors for which ground-based and balloon tests will be essential. Laboratory measurements of atomic data are necessary to link observations to scientific conclusions.

Theory provides the intellectual context for any scientific effort. Theoretical work is essential to the conception and design of missions and to the interpretation of the data they provide—especially for the *Beyond Einstein* missions, which are designed to test predictions that challenge our beliefs.

### Education and Public Outreach

*Beyond Einstein* offers an unparalleled opportunity to involve the public in the excitement of cosmic exploration, and to inspire and cultivate the next generation of scientists and engineers. The public's eagerness to share this adventure is reflected in part by the many Hollywood movies, television series, bestselling books, and popular articles that draw on



*Beyond Einstein* themes. The origin of the Universe and black holes are central to K-12 science literacy standards and curricula. The television shows and educational materials for “Live from a Black Hole” and “Live from the Edge of Space” reached an estimated five million students. Public television’s NOVA program on dark energy (*Runaway Universe*) was seen initially by more than two million Americans. The *Beyond Einstein* themes will soon provide the *majority* of materials on these subjects in our nation’s schools and the missions will weave an ongoing story that is one of the most compelling in all science.

### ***Einstein’s Legacy***

Einstein sought, but never achieved, an understanding of how nature works at its deepest level. We now seek the next level of Einstein’s quest through a program of missions we can conceive and design today and carry out over the next decade. In the future, the “vision missions” of this roadmap will extend these ventures even closer to the edges of space and time. We will follow matter to the very brink of black holes and detect quanta or particles of time left over from the beginning of the Universe. We will use breakthrough technologies to see beyond the vision of Einstein—to the uttermost extremities of existence.

*“Each one has the right to share in the knowledge and understanding which society provides”  
—Albert Einstein*

## Chapter 2. Scientific Goals and Missions

### Beyond Einstein: The Science

A century ago, Albert Einstein began creating his theory of relativity—the ideas we use to understand space, time, and gravity—and took some of the first steps towards the theory of quantum mechanics, the ideas we use to understand matter and energy. *Time* magazine named Einstein the “Person of the Century” because his ideas transformed civilization, but his work is not finished: spacetime is not yet reconciled with the quantum.

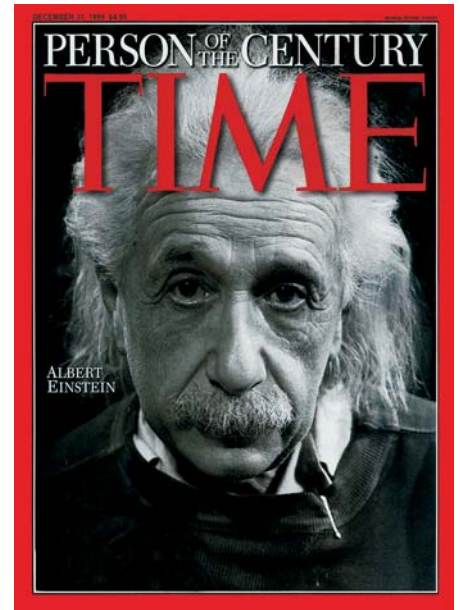

*“The most beautiful thing we can experience is the mysterious. It is the source of all true art and science. Those to whom this emotion is a stranger, who can no longer pause to wonder and stand rapt in awe, are as good as dead: their eyes are closed.”*

—Albert Einstein

Einstein’s general theory of relativity opened possibilities for the formation and structure of the Universe that seemed unbelievable even to Einstein himself but which have all been subsequently confirmed: that the whole Universe began in a hot, dense Big Bang from which all of space expanded; that dense matter could tie spacetime into tangled knots called black holes; that “empty” space might contain energy with repulsive gravity. Despite these discoveries, we still do not understand conditions at the beginning of the Universe, how space and time behave at the edge of a black hole, or why distant galaxies are accelerating away from us. These phenomena represent the most extreme interactions of matter and energy with space and time. They are the places to look for clues to the next fundamental revolution in understanding—Beyond Einstein.

### Edges of Spacetime and Black Hole Horizons

Most of what we know about gravity comes from experiments within the Solar System, where gravity is weak. These confirm Einstein’s theory that gravity is the one universal force connecting all forms of mass and energy. It is universal because it is a property of space and time itself.

Einstein’s general theory of relativity predicts that gravity should appear in its purest form in two ways: in vibrations of spacetime called gravitational waves, and in dense knots of curved spacetime called black holes. So far we have only circumstantial indications that these two astonishing predictions are true. *Beyond Einstein* missions will obtain *direct* evidence. Only data collected from these so-far invisible regimes can enable us to find out whether Einstein’s theory is complete.

If it is, Einstein’s theory tells us that a black hole is made of pure gravitational energy. It can have mass and spin but should contain no matter. Though we know the Universe contains many black holes, we have yet to see one in detail. The general theory of relativity provides a mathematical picture of what one should be like. At the heart is a singularity, where space and time are infinitely curved and

Chandra X-ray Observatory image of possible intermediate mass black holes accreting gas in the Antennae pair of colliding galaxies.

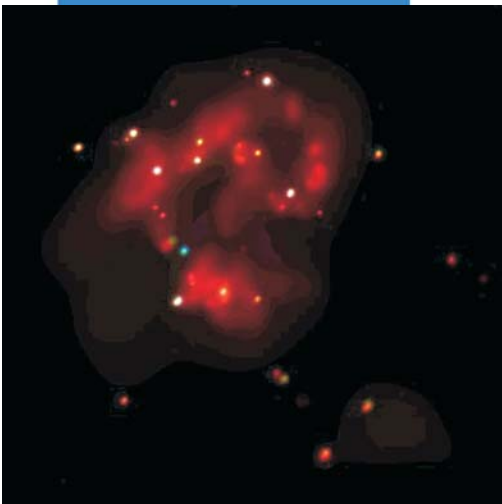

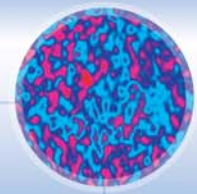

big bang

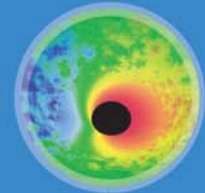

black holes



dark energy

*“I was immediately hooked! You are stirring the imagination and interest of today’s kids!”  
—Testimonial from user of Chandra education materials*

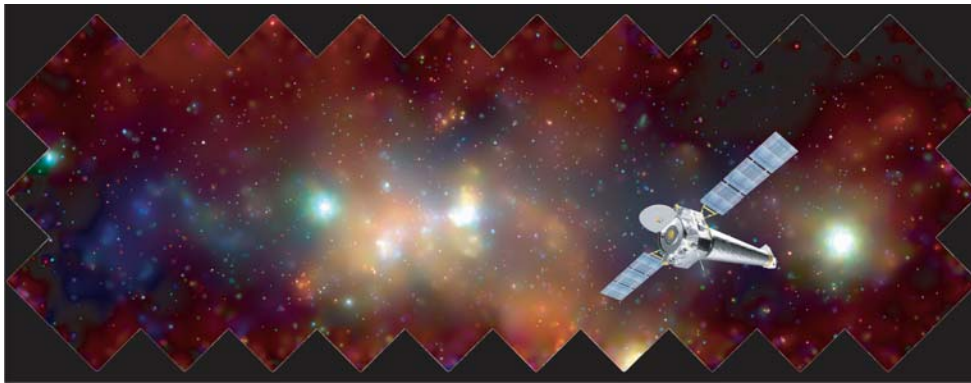

NASA’s Chandra X-ray Observatory was launched in 1999. It is named after the Nobel Laureate Subrahmanyan Chandrasekhar, who developed the detailed mathematical theory of collapsed stars. Some of the Observatory’s greatest discoveries include:

- Evidence for black holes of mass intermediate between those of stars and the supermassive black holes in galactic nuclei.
- Evidence that the X-ray background is produced by black holes so obscured by gas and dust as to be invisible to optical telescopes.
- Evidence for astonishingly bright clumps or rings of matter falling into black holes.
- Evidence that black holes in binary star systems are indeed bottomless holes as Einstein’s theory predicts.

energy is infinitely concentrated. Around the singularity is a region from which nothing can escape. The edge of this region is called the event horizon. There, time is so warped that it seems, from outside, to have stopped.

How could we find out if such objects really behave in this weird way? We could drop an astronaut near a black hole. As she fell in, Einstein predicts that the hands of her watch would appear to us to slow down and practically stop as she approached the event horizon. But she and her watch would fade from view so rapidly that we could never see her (or her watch) cross the event horizon. Yet to the falling astronaut, everything would seem normal as she crossed the event horizon. Unfortunately once across, nothing could save her. Tides would rip her to pieces near the central singularity.

Fortunately, there are more humane ways to find out if black holes are really as Einstein predicts. We can instead observe radiation from atoms of gas as they fall in. The frequency of their light is like the ticks of a clock. Changes in that frequency are caused by the motion of the gas—the familiar “Doppler effect” change in tone you hear as an ambulance races past—and by

“The black holes of nature are the most perfect macroscopic objects there are in the Universe: the only elements in their construction are our concepts of space and time.”

—Subrahmanyan Chandrasekhar  
[Nobel Prize, 1983]





When we talk about observing the sky in radio waves or X-rays, we talk about “seeing” things, even though our eyes cannot see radio waves or X-rays. Similarly, we refer to “hearing” gravitational waves even though they are vibrations in the fabric of spacetime, not the vibrations of water or air that our ears hear.

Because  $E = mc^2$ , the energy of curved spacetime has mass. A black hole is a knot in spacetime so curved that the mass-energy of the curvature can keep the knot from unraveling. To describe everything about an isolated black hole, one needs only two numbers: its mass and its spin. Electric charge is shorted out. No other deviations from smooth perfection are possible: no mountains, no magnetic fields, no anything else. Physicists say that “black holes have no hair.”

Because of this no-hair rule, the orbits of stars and other bodies around black holes are determined entirely by the mass and spin of the black hole. The orbiting bodies vibrate spacetime. The LISA mission will use these vibrations (gravitational waves) to track their orbits and show whether the black holes are really as “bald” as Einstein’s theory predicts.

the gravitational redshift due to spacetime curvature. Watching the spectra of these flows can thus reveal many details of the matter and its spacetime environment.

The light from these atoms can be very bright. Streams of matter falling into a black hole accelerate to nearly the speed of light; when they collide, they heat up and radiate enormous amounts of light. A car powered with a black hole engine would get a billion miles to the gallon. Mass-energy not radiated falls into the hole, adding to its mass and spin. The spin of the hole can give matter nearby a kick and, with the aid of magnetic fields, can even accelerate it into powerful jets of outflowing particles.

The *Beyond Einstein* program will systematically determine the fate of this matter. The Black Hole Finder Probe will survey the Universe seeking radiation from matter falling into black holes and mapping their locations; Constellation-X will study the spectra of atoms as they fall in; and in the distant future, the Black Hole Imager will create moving images of the swirling matter right down to the edge of the event horizon.

### ***Cosmic Cacophony: Gravitational Waves***

Black holes can also be studied by listening for the “sounds” they create, a novel form of energy called gravitational waves.

Since ancient times, astronomers have used one form of energy to study the Universe. Called simply “light,” it includes X rays and radio waves and all the colors of the rainbow in between. Light is made of vibrating waves of electric and magnetic fields traveling through space.

In Einstein’s theory of gravity, energy can also be carried by vibrating waves of space and time, which travel at the speed of light. In the same way that black holes are made just of space and time, gravitational waves are also “pure” space and time. They interact very weakly with matter and penetrate anything without losing strength. While this makes them powerful probes of extreme conditions, it also makes them hard to detect. They interact so weakly with measuring apparatus that only in the past few years

The Sun and planets of the Solar System very slightly bend space and time, causing them to fall around each other, and satellites to fall around the Earth. A black hole bends space and time so tremendously that time stops at its horizon’s edge and neither matter nor energy can escape from within the horizon.

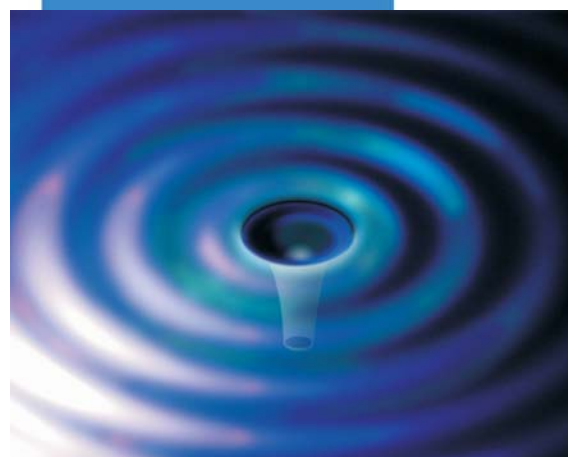
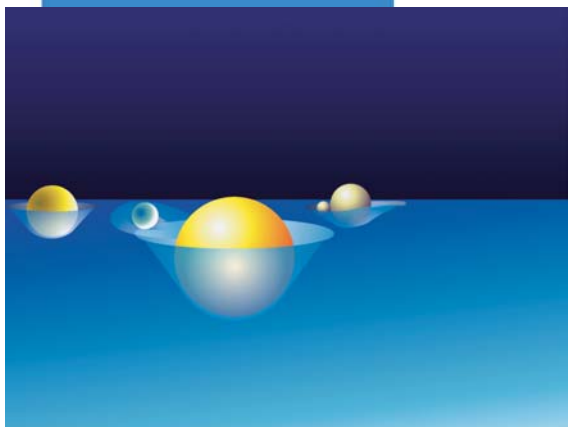

has technology advanced to the point that we are confident we can build equipment to detect them.

The most powerful outflows of energy in the Universe are not carried by light but by gravitational waves emitted when two black holes orbit, collide, and merge. In the final minutes or hours before the merging of a single pair of supermassive black holes, a gravitational power of about  $10^{52}$  watts is radiated. This is a million times more power than all the light from all the stars in all the galaxies in the visible Universe put together, and millions of times more powerful than the most powerful single sources of light: gamma-ray bursts. It is possible that the Universe contains more of this gravitational radiation than it does light.

Detecting gravitational waves will give Einstein's theory a workout it has never had before. We know that it works pretty well in normal circumstances—without “spacetime curvature technology” in their software, airplanes using GPS navigation would miss their runways by miles—but gravitational waves offer much more profound potential. They will let us listen carefully to the most violent events in the Universe, the collision and mergers of black holes. What goes on there is a swirling knot of spacetime interacting mostly with itself. A black hole merger can also briefly expose to observation the singularity at the heart of the black hole, where Einstein's theory must fail. The sounds of the Universe will tell us how well Einstein's ideas still work in these extreme conditions. They will also allow us to penetrate times and places impossible to see with ordinary light, such as the birth of our Universe. They might reveal startlingly violent events, such as the formation of our three-dimensional space from an original space with more dimensions.

Gravitational waves produce tiny jiggles between masses that are floating freely in space, isolated from all forces other than gravity. The distances between the masses can be monitored using laser interferometry. An early generation of such systems has now been deployed on the ground—the NSF-funded Laser Interferometer Gravity-wave Observatory (LIGO) in the US and similar systems worldwide. It is hoped that these systems will make the first detection of gravitational waves from some sources of high-frequency waves. The *Beyond Einstein* Great Observatory LISA will operate in a broad band at much lower frequency. It will detect entirely different sources in great numbers and with exquisite precision.

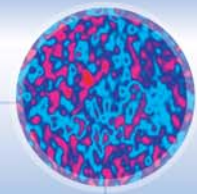

big bang

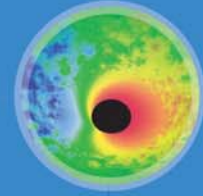

black holes



dark energy

In 1967, the first radio pulsar was discovered by Jocelyn Bell and Anthony Hewish (for which Hewish received the Nobel Prize in 1974). Pulsars were quickly identified as neutron stars, the incredibly compressed remnants of the supernova explosion of stars.

In 1974, Russell Hulse and Joseph Taylor discovered the first binary pulsar PSR 1913+16: one of two neutron stars orbiting each other every 8 hours. The general theory of relativity predicts that as the stars orbit each other, they stir spacetime around them and radiate gravitational waves, causing them to spiral together.

In 1993, Taylor and Hulse received the Nobel prize for showing that since 1974 the neutron stars have been spiraling towards each other at exactly the rate Einstein's theory predicts, due to gravitational waves. The gravitational waves from binary stars like this await direct detection by LISA and LIGO.

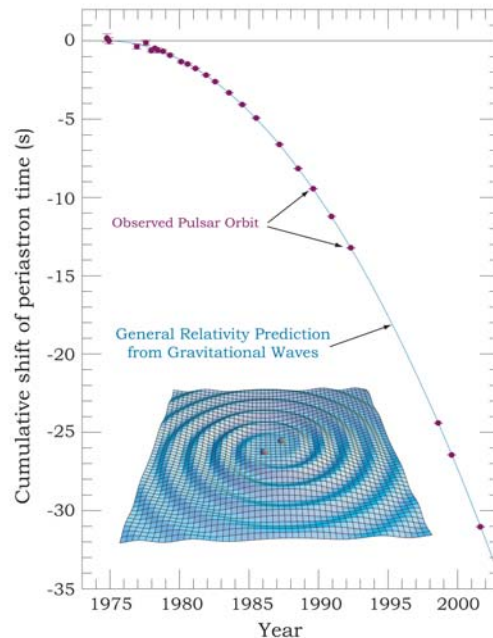

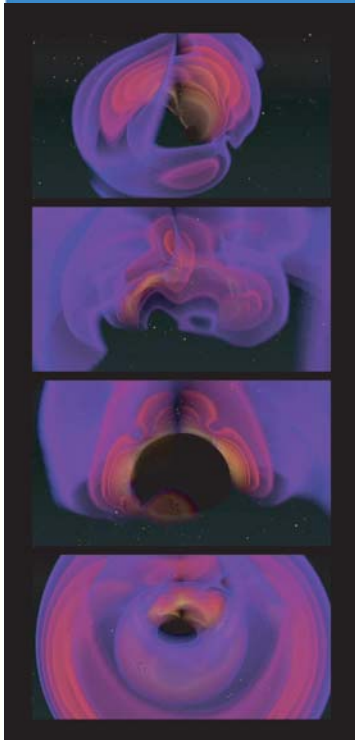

Supercomputer calculation of the gravitational waves produced in the merger of two supermassive black holes (Courtesy E. Seidel and W. Bengert)

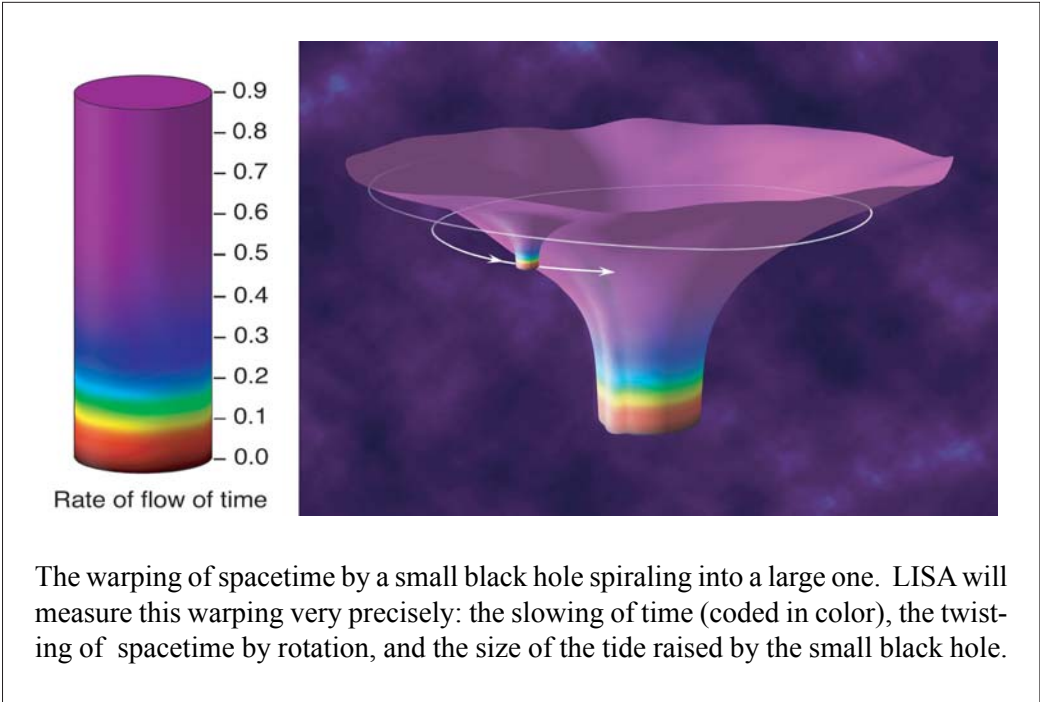

The warping of spacetime by a small black hole spiraling into a large one. LISA will measure this warping very precisely: the slowing of time (coded in color), the twisting of spacetime by rotation, and the size of the tide raised by the small black hole.

The most powerful gravitational waves come from quickly-changing systems with very strong gravity, so LISA’s strongest signals will probably be tones from black holes spiraling into other supermassive black holes. LISA will also detect for the first time gravitational waves from calibrator sources (such as orbiting pairs of white dwarf stars) that have been studied by optical telescopes.

LISA will break ground for the new science of gravitational wave astronomy. The vision mission Big Bang Observer will extend the reach of gravitational wave astronomy towards its ultimate limit—detecting the quantum noise from the inflationary Universe.

### *The Beginning of Time*

The Universe is expanding, and abundant evidence now shows that it began in a hot, dense state—the Big Bang. The general theory of relativity explains how the expanding Universe works, but on its own it does not explain what made the Big Bang happen in the first place.

Clues have been found in the relic heat from the Big Bang, the Cosmic Microwave Background (CMB). Light that has been traveling to us since the Universe was 300,000 years old. Observations reveal minute temperature fluctuations in the brightness of the CMB that show that the matter content of our Universe, while remarkably smooth when the relic heat began its journey to us, had already been imprinted with perturbations at a much earlier time. These have now grown into the galaxies of stars illuminating our sky. We are therefore faced with a conundrum: Why has matter in the Universe *clumped* into galaxies and clusters of galaxies spread *smoothly* throughout space?

“Inflationary cosmology” provides one explanation of why the Universe is very smooth, yet not perfectly so. A still-mysterious form of energy generated a repulsive force that caused the early Universe to expand at a fantastic rate. This expansion stretched and smoothed any existing inhomogeneities in spacetime.

But the inflation field, like all energy fields, was subject to quantum fluctuations. These led to imperfections in the cosmic expansion—the Big Bang got a slightly bigger kick in some places than in others. The effect of a single quantum fluctuation was enor-

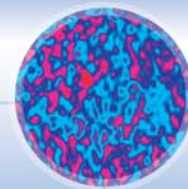

big bang

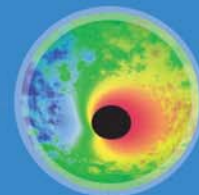

black holes



dark energy

*"I am so thankful that I just saw on TV the Runaway Universe today and then discovered this website tonight. How can we be so lucky as to have these educational tools available? While I am a great-grandmother of two and have not studied chemistry, math or physics ever, I am hooked. Please keep giving this inspiring information to us and especially to the young future scientists."  
—Betty H., NC.*

In 1978 Arno Penzias and Robert Wilson received the Nobel prize for their 1965 discovery of the cosmic microwave background (CMB), which showed that our Universe began with a hot and nearly uniform Big Bang. This microwave radiation has been propagating towards us since the atoms in the Universe formed, when the Universe was 300,000 years old.



*Arno Penzias and Robert Wilson and the historic Bell Labs horn antenna, discoverers of the relic Cosmic Microwave Background of the Big Bang.*

Within a few years of this discovery, theoretical astrophysicists around the world predicted that because the Universe today is not uniform, the CMB should not look precisely uniform either. It should show seeds of the irregularities which would later turn into clustering galaxies. In 1989, NASA launched the Cosmic Background Explorer (COBE), and it discovered these predicted nonuniformities.

In 2000, an NSF/NASA balloon flight, BOOMERanG, for the first time mapped the details of the microwave background fluctuations in a small region of the sky.

The Microwave Anisotropy Probe (MAP), a NASA mission launched in June 2001, is making measurements of these small-scale nonuniformities over the entire sky. The resulting map will reveal the geometry of the Universe and the nature of primordial perturbations. MAP will also help determine the baryon density, Hubble parameter, dark matter density, and dark energy density, all indicators of the contents of the Universe.

mously inflated along with the Universe itself. Sky maps of the CMB show a pattern of fluctuations very much like that predicted by inflation.

Nevertheless, we are far from certain that the inflationary scenario is correct. Even if inflation is the right story, the details of the process remain a mystery. We need new data to help decide whether the early Universe underwent a period of rapid inflation, and if so, what was the mechanism responsible for driving it.

We now understand a way to uncover these secrets. Calculations predict that in addition to its energy field fluctuations, inflation should have created single "particles of spacetime" called gravitons. The gravitational waves of longest wavelength (with periods of three billion years!) should have left a subtle pattern in the polarization of the light of the CMB.

The "Inflation Probe" will seek this subtle pattern. The strength and details of the pattern will tell us about the properties of the mysterious inflation field that powered the Big Bang.

## COMPOSITION OF THE COSMOS

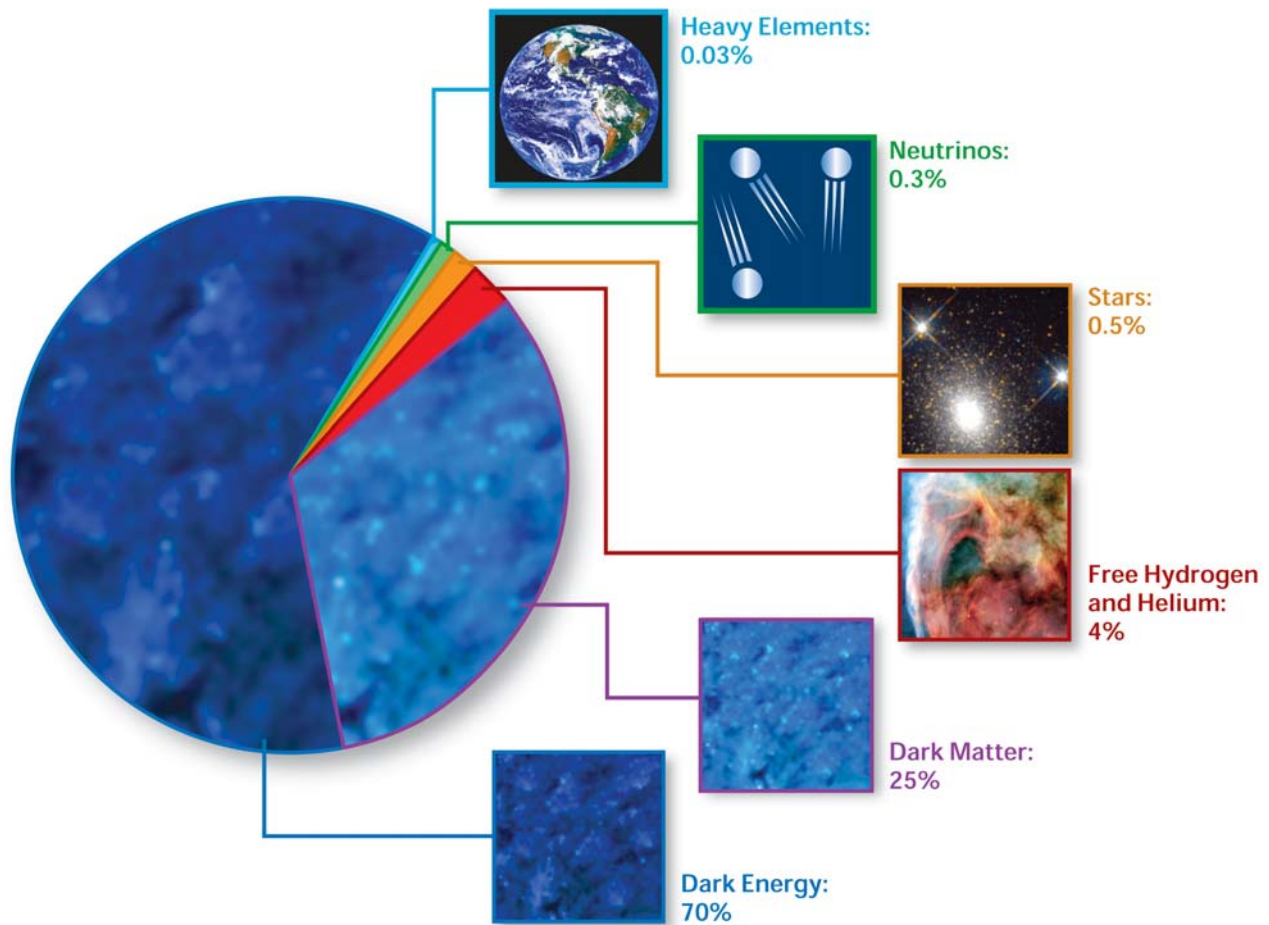

When first broadcast, NOVA's television show *Runaway Universe on dark energy* was watched by 2.1 million Americans—almost as many (as all) cable news network stations combined.

### *Dark Energy and the Accelerating Universe*

Deep as Einstein's general theory of relativity may be, it remains silent on a profound question: Is empty space really empty? Inflation models predict that it was not so in the past, and it may not be so today either. Einstein introduced a "cosmological constant" into his equations, to represent the possibility that even empty space has energy and couples to gravity. The unknown magnitude of the cosmological constant is set by parts of physics beyond Einstein's understanding—and, at present, our own.

The new discovery that the expansion of the Universe appears to be accelerating suggests the presence of something dubbed "dark energy" that drives space apart. It seems likely that we have roughly measured the value of a cosmological constant or something like it.

This new discovery is already widely accepted because it explains many observations. The first indication was that the rate of expansion of the Universe has been increasing, revealed by Type Ia supernovae. Supporting evidence comes from studies of global geometry, structure formation, cosmic age, and galaxy clustering. They leave little doubt that in some sense Einstein's "cosmological constant" is a reality. The energy of the Universe is dominated by empty space whose gravitational effect is to pull the Universe apart.

The 2002 Nobel Prize in Physics was shared by scientists who opened two new windows on the Universe.



In 1962, **Riccardo Giacconi** detected for the first time a source of X-rays outside our Solar System, using a detector in the nose cone of an Aerobee rocket. Observations with his pioneering *Uhuru* satellite led to the discovery of several sources of X rays that most astronomers now believe contain black holes. Giacconi constructed the first X-ray telescopes, which have provided us with completely new images of the Universe. His contributions laid the foundations of X-ray astronomy. The company that built these early astronomical X-ray detectors also developed high resolution Computed Tomography (CT) scanning of the human body and the X-ray inspection systems used to detect illegal substances

and weapons in packages, trucks, and cargo containers.

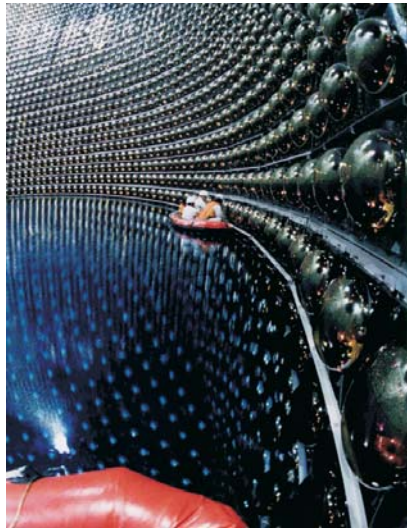

Neutrinos are particles that interact only weakly with ordinary matter, so neutrino detectors must be enormous and precise. The gigantic instruments constructed by **Raymond Davis Jr.** and **Masatoshi Koshiba** detected neutrinos from the Sun and confirmed the prediction that the Sun is powered by nuclear fusion. Koshiba's instrument also detected the neutrinos from Supernova 1987A, proving that supernovae create hot neutron stars that cool by radiating neutrinos. Davis and Koshiba created the field of neutrino astronomy. Their experiments also made the unexpected discovery that neutrinos have mass—the neutrinos in the Universe have nearly as much mass as all of the stars!

Constellation-X is the next great step in the development of X-ray astronomy blazed by Giacconi. And like the instruments of Davis and Koshiba, LISA will open for mankind a completely new window on the Universe and create the field of gravitational wave astronomy.

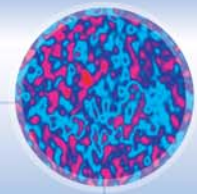

big bang

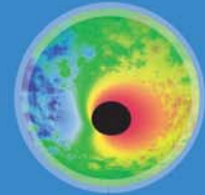

black holes



dark energy

*“The real voyage of discovery consists not in seeking new landscapes, but in having new eyes.”  
—Marcel Proust*

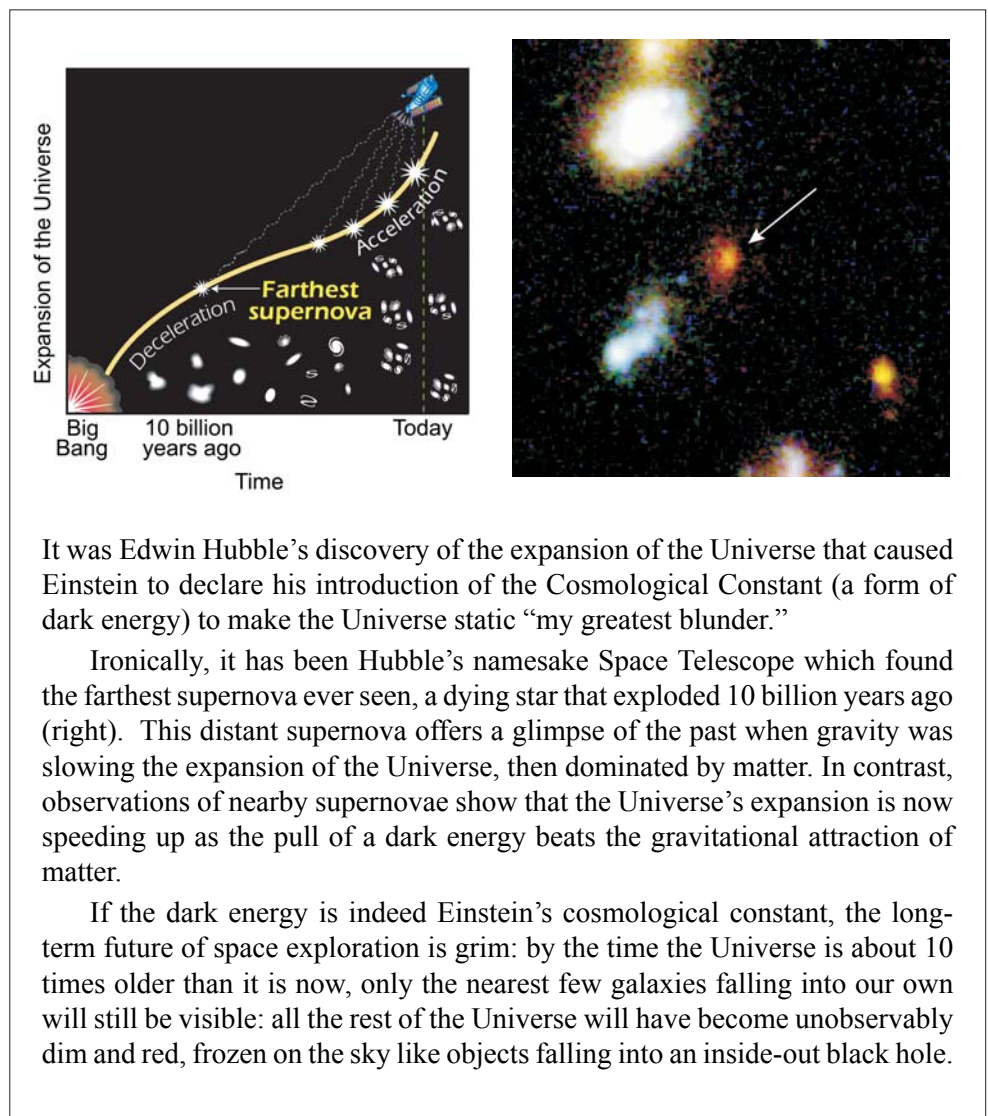

It was Edwin Hubble's discovery of the expansion of the Universe that caused Einstein to declare his introduction of the Cosmological Constant (a form of dark energy) to make the Universe static "my greatest blunder."

Ironically, it has been Hubble's namesake Space Telescope which found the farthest supernova ever seen, a dying star that exploded 10 billion years ago (right). This distant supernova offers a glimpse of the past when gravity was slowing the expansion of the Universe, then dominated by matter. In contrast, observations of nearby supernovae show that the Universe's expansion is now speeding up as the pull of a dark energy beats the gravitational attraction of matter.

If the dark energy is indeed Einstein's cosmological constant, the long-term future of space exploration is grim: by the time the Universe is about 10 times older than it is now, only the nearest few galaxies falling into our own will still be visible: all the rest of the Universe will have become unobservably dim and red, frozen on the sky like objects falling into an inside-out black hole.

Since we have no theory of dark energy, anything we learn is an unexpected discovery. Our current understanding of how quantum mechanics and gravity are united predicts an amount of dark energy larger than observed by a factor of  $10^{120}$ . Some modern theories predict that the amount of dark energy decreases with time, instead of staying constant as in Einstein's conception. For this very reason, dark energy is the most exciting new development in fundamental physics. Because dark energy seems to control the expansion of the Universe, we cannot predict the fate of the Universe without understanding the physical nature of dark energy. As we develop this understanding, we will be poised to answer the profound question: will the Universe last forever?

As we look at our Universe today, we estimate that it consists of five percent ordinary matter (stars, planets, gas, and dust), twenty-five percent "non-baryonic" dark matter (as-yet-undiscovered particles unlike ordinary "baryonic" matter), and seventy percent dark energy (which can be considered to have mass, too, because energy  $E = mc^2$ ).

To learn how dark energy really works, we need to measure its properties in more detail. It is spread so thin that it can only be studied in space, where the enormous volume allows its effects to be noticed. The first step will be to measure its density and pressure

and how they change with time. The Dark Energy Probe will deploy the best available technology to study this effect. Constellation-X, LISA, and the Inflation Probe will provide independent constraints to verify and increase the measurement precision.

The small samples provided by the Hubble Space Telescope show that a dedicated, special-purpose instrument could provide a much better measurement of the bulk properties of the dark matter. These determine whether the energy is really constant, as Einstein conjectured, or whether it has changed over cosmic time, as suggested by some string theorists. Real data on this question would help us discover where dark energy comes from, and what the future of our Universe will be.

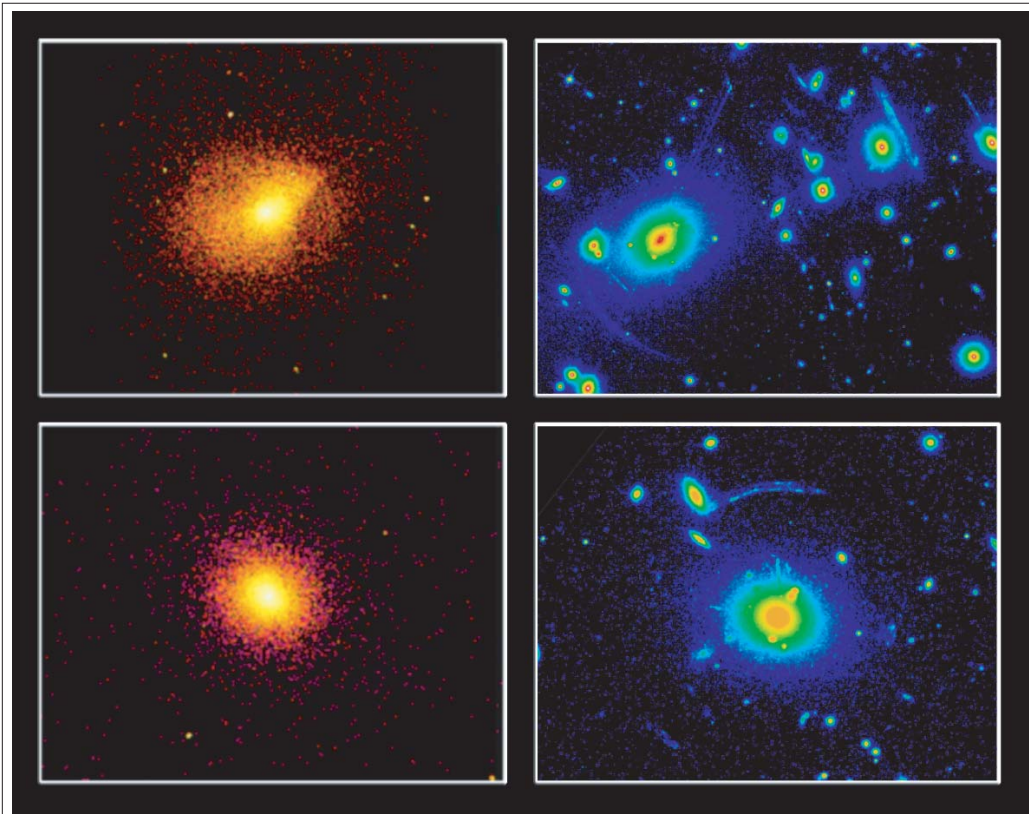

Observations of distant clusters of galaxies also provide independent evidence for dark energy. This montage shows two sets of Chandra X-ray Observatory images (left) and Hubble Space Telescope images (right) of two giant galaxy clusters. Most of the mass is in the form of dark matter. The X ray emission comes from the multimillion-degree gas that fills the clusters. Chandra provides detailed temperature maps for this gas to precisely determine the masses of the clusters. The gravity of the dark matter acts as a large cosmic lens on the light from distant background galaxies to produce the giant arcs seen in the images. The Hubble Space Telescope data place independent constraints on the masses of the clusters that confirm the Chandra results.

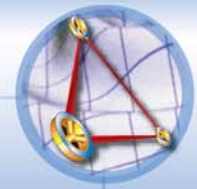

laser  
interferometer  
space antenna



constellation-x

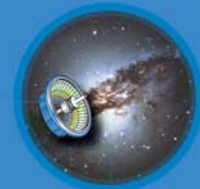

einstein probes



**Interagency Connections.** Astronomical discoveries are driving the frontiers of fundamental physics and progress in fundamental physics is driving progress in understanding the Universe. *Beyond Einstein* will thus cut across the disciplines of physics and astronomy supported by DOE, NASA, and NSF. The unique capabilities of all three agencies will be essential to a coordinated attack on the science questions. This Roadmap draws on the 2000 tri-agency *Connections* science plan and implements the priorities for NASA in the 2002 report by the National Academy of Sciences Committee on the Physics of the Universe, *Connecting Quarks with the Cosmos*. Interagency partnerships will form a key component of the Einstein Probes, as they have in the GLAST mission.

### ***Beyond Einstein: The Program***

The program has three major elements that work together towards the twin visions of directly observing the birth of the Universe and directly imaging matter near the edge of a black hole. The cornerstones of the program are two Einstein Great Observatories, Constellation-X and LISA. These will provide dramatic new ways to answer questions about black holes, the Big Bang, and dark energy. The second element is a focused line of moderate-sized Einstein probes, each dedicated to the study of a specific deep question. The third element is a supporting program of forward-looking technology development, theoretical studies, and education and public outreach. Together, the three elements will enable us to grasp these questions, prove the technology to enable missions that realize the twin visions of the Beyond Einstein program, and inspire the next generation of scientists and engineers.

#### ***The Einstein Great Observatories***

Constellation-X and LISA will use the complementary techniques of X-ray spectroscopy and gravitational waves to study black holes. They will probe space, time, and matter in the extreme environment near black holes and track their evolution with cosmic time. These two facilities will be a major resource for a broad astronomy and physics community. The National Academy of Sciences' decadal survey *Astronomy and Astrophysics in the New Millennium* developed community consensus on the most important science questions and funding priorities. It recommended both LISA and Constellation-X as high priorities for this decade.

Constellation-X will extend our capability for high resolution X-ray spectroscopy by 25 to 100 times. Its key goals are to determine the fate of gas falling into a black hole by tracking spectral features close to the event horizon, and to trace the evolution of black holes with cosmic time by obtaining detailed spectra of faint quasars at high redshift. The mission is optimized for these challenges but also provides the ability to observe other objects with unprecedented sensitivity. Constellation-X will also observe the first clusters of galaxies and be able to search for spectral features from the surfaces of neutron stars, which could finally determine the properties of matter at nuclear density.

LISA's gravitational waves offer an entirely new way to sense action in the Universe. Through them we will hear for the first time the mergers of giant black holes and the death spirals of stars they capture and swallow. Using these, we will map the knotted structure of space and time around a black hole and determine if the astonishing predictions of Einstein's theory are correct: the freezing of time and dragging of space around a black hole. LISA will also make the first complete map of merging binary stars in our Galaxy,

*"The most  
incomprehensible thing  
about the Universe  
is that it is  
comprehensible."  
—Albert Einstein*

**National Priorities.** The *Beyond Einstein* science program complies extremely well with the recommendations of recent reports of the National Academy of Sciences: the decadal survey *Astronomy and Astrophysics in the New Millennium* (Astronomy and Astrophysics Survey Committee, 2001), *Connecting Quarks with the Cosmos* (Committee on the Physics of the Universe, 2002), and *Gravitational Physics: Exploring the Structure of Space and Time* (Committee on Gravitational Physics, 1999).

All *Beyond Einstein* missions have been recommended by the National Academy of Sciences. Both LISA and Constellation-X are highly ranked and strongly recommended in the two aforementioned NAS reports. Furthermore, candidate implementations of both the Dark Energy Probe (SNAP) and the Inflation Probe (CMBPol) are recommended by the Committee on Physics of the Universe. A candidate implementation of the Black Hole Finder Probe (EXIST) is recommended by the decadal survey of the Astronomy and Astrophysics Survey Committee.



laser  
interferometer  
space antenna



constellation-x

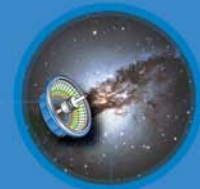

einstein probes

future supernovae which could affect life on Earth. It will set important limits on background radiation from the early Universe and from catastrophic events, such as phase transitions in the vacuum or changes in the dimensionality of the Universe.

Both Constellation-X and LISA are critical to the goals of the *Beyond Einstein* program. One of these great observatories will begin development at the beginning of the program, and the other will begin development approximately 3 years later. NASA will determine the order based on science priority, technological readiness, and programmatic considerations.

### *The Einstein Probes*

The Einstein Probe line is designed to address those critical science goals of the *Beyond Einstein* program which do not require facility-class observatories. The first three of these are:

- Determine the nature of the dark energy that dominates the Universe.
- Search for the imprint of gravitational waves from inflation in the polarization of the cosmic microwave background.
- Survey the Universe for black holes.

The Einstein Probes will be fully competed, scientist-led mission opportunities. Yet they will be focused on the specific scientific mysteries identified in this strategic plan. To minimize cost and maximize science return, multiple approaches to each goal will be developed and scrutinized before mission selection. An associated technology program will enable this. Some Einstein Probes may include substantial contributions from other agencies (national and international). The goal is to launch one every three years, starting about 2010.

The Einstein Probes address focused science questions identified as high priorities by the science community. The Committee on the Physics of the Universe (CPU) gave high

**International Connections.** International participation is a key feature of *Beyond Einstein*. The LISA mission is an equal venture between NASA and ESA, with the ESA participation fully approved. Constellation-X and the Einstein Probes have attracted international interest that will be realized when the instruments are competitively selected.

priority to determining the nature of dark energy. Polarization of the cosmic microwave background, an imprint of gravitational waves from the period of inflation, will set limits on the amplitude and frequency distribution of these waves. The study of the polarization of the cosmic microwave background was identified as an important area by the AASC report, and an Inflation Probe is a high priority recommendation in the CPU report. It is an essential prelude to embarking on a much more ambitious mission to detect the radiation directly with a Big Bang Observer. A survey of black holes by a Black Hole Finder Probe will provide a monitor for transient events that can be followed up with Constellation-X and LISA and also find targets for the Black Hole Imager. The importance of such a mission is highlighted in the AASC report.

The order in which the Einstein Probes are flown will be determined by both science priority and technological readiness. NASA will conduct mission concept studies for the Einstein Probes in order to assess mission concepts for each Einstein Probe and to evaluate their technical needs. These studies, proposed and conducted by community-based collaborations, will be fully competed and will provide the information necessary to define the technology program and later set the launch order for the Einstein Probes.

### ***Technology and Theory***

Vigorous technology development is essential for the *Beyond Einstein* program to succeed. For the Einstein Great Observatories, technology roadmaps are in place; the *Beyond Einstein* program includes the resources needed to implement them. For the Einstein Probes, key technologies must be demonstrated before the mission competitions can occur. The vision missions require a focused program to develop necessary new technologies. The National Academy of Sciences reports endorse the program leading to these vision missions: the AASC recommended investment in X-ray interferometry (for the Black Hole Imager), and the CPU report recommended development for a multi-interferometer gravitational wave mission capable of “nulling out” astrophysical foregrounds (needed for the Big Bang Observer).

The successes of COBE and MAP owe considerable debt to theoretical studies. The programs of our roadmap are similarly complex and require an investment in theoretical modeling at all levels: from astrophysics to instrument response. Early, explicit, and stable support for theory will lay the conceptual foundations of projects, develop mission-critical analysis and modeling software, foster the growth of teams, provide training for a larger community, and help provide leadership in educational outreach. The *Beyond Einstein* program addresses these needs by including theory as part of the advanced technology needed for program success; this is consistent with the recommendation of the AASC.

### ***Education and Public Outreach***

Few scientific ventures have as much inherent power to capture the public imagination as the *Beyond Einstein* program. This power will be used to inspire the next generation of scientists, engineers, and teachers, and to support the education of our nation’s students. Lesson plans and curricula based on *Beyond Einstein* will enhance science literacy. Through in-service training, the program will bring new excitement to the nation’s science class-

“Exploring the cosmos has been something I have been drawn to for as long as I can remember. I am most interested in learning about the beginning and end of the Universe, and also exploration into black holes in terms of their role in the Universe.”  
—from a high school sophomore responding to the GLAST Web site

## BEYOND EINSTEIN TIMELINE

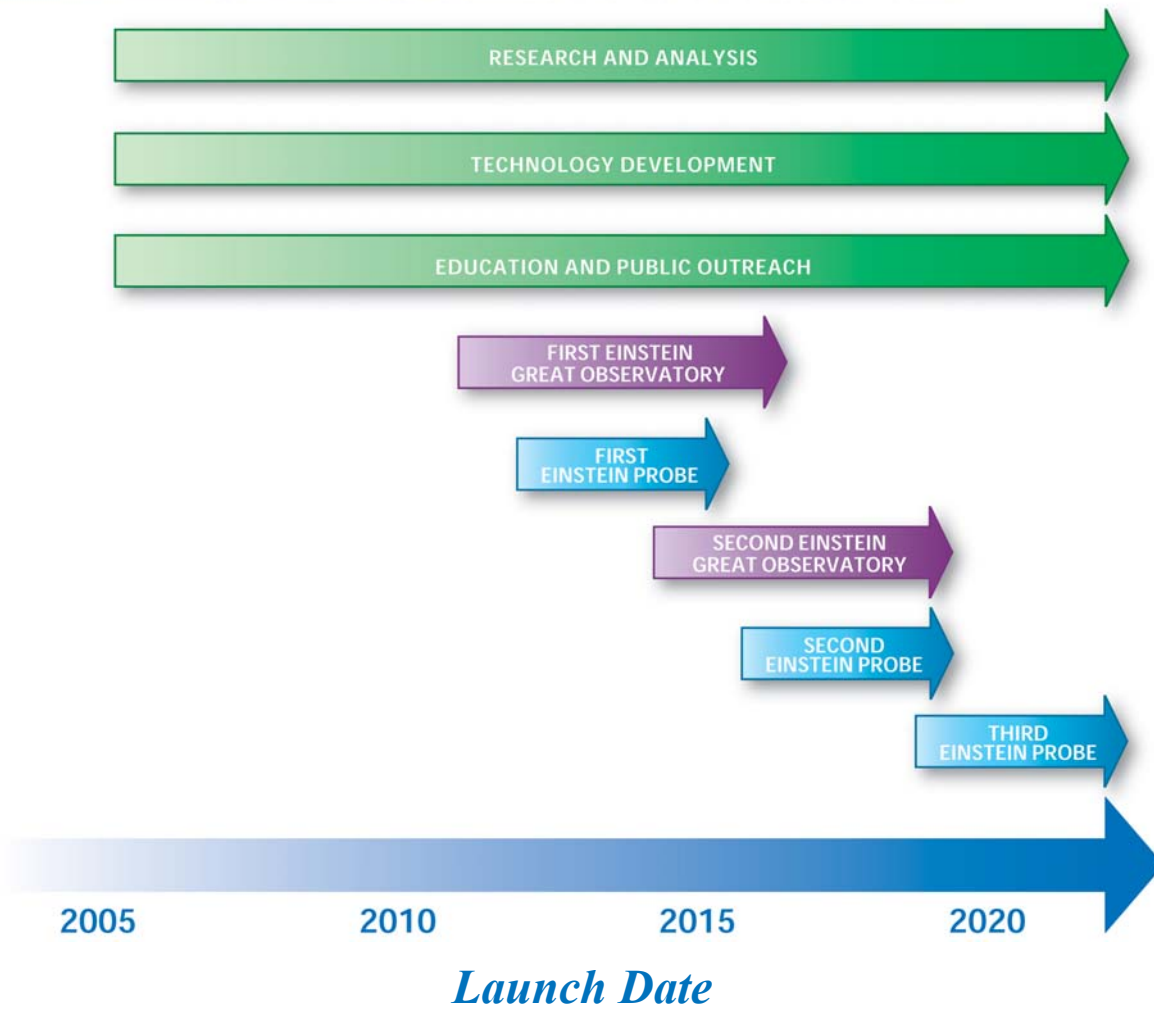

rooms. Space scientists will bring passion to all levels of education and outreach. They will emphasize the human drama of the quest, in which people of remarkably diverse backgrounds and skills come together to design, build, and launch missions, and to develop the critical technologies that make them possible.

### *An Integrated Program*

The three elements of the *Beyond Einstein* program are tightly linked. The vision missions will make direct measurement of signals from the true boundaries of our Universe. Constellation-X and LISA can be realized within the next decade and address pressing near-term science questions. The answers to these questions are critical to planning the scientific and technical direction of the missions which follow. The Einstein Probes address focused questions that will influence the design and observations of the more ambitious missions. The overall program is knitted together by shared theory, technology, research, and outreach.

Constellation-X will constrain the distribution of X-ray emitting matter near black holes. This is an essential step, both to prove the feasibility of imaging X-ray emission close to the event horizon and to optimize the design of the Black Hole Imager vision mission.

**Competition Strategy.** The acquisition strategy for *Beyond Einstein* supports the *President's Management Agenda*. The scientific goals and mission metrics are clearly defined. Maximal citizen-centered competition will be ensured by competitively selecting: (i) All NASA-provided components of the Einstein Great Observatories, LISA and Constellation-X. These include the science team, instrument providers, and spacecraft provider. (ii) The complete mission concept for the Einstein Probe missions. The proposal teams will comprise university, industry, NASA center, and government lab partners. (iii) All research, technology, and education/public outreach components of the program.

The Einstein Probes will be PI-class missions. A PI-class mission is developed by a team headed by a principal investigator (PI). The team is assembled from the university, industry, and government community by the PI. Teams propose the mission concepts and implementation strategy, including management and cost controls. NASA competitively selects one PI-led team to implement the mission under NASA's oversight. PI-class missions have been highly successful and scientifically productive in NASA's Explorer and Discovery Programs. This approach will ensure the most cost-effective, science-driven approach to the missions, promoting innovation through competition.

LISA will pioneer gravitational radiation detection in space and will make the first direct detection of waves with periods between hours and seconds. LISA and LIGO measurements together will allow us to predict the background faced by the Big Bang Observer. Combined with the results from the Inflation Probe, these will determine the frequency range and sensitivity requirements for the Big Bang Observer. Experience with LISA will determine its design.

## ***Beyond Einstein: The Missions***

### ***Einstein Great Observatories***

#### **Constellation X**

Constellation-X will measure the velocities and conditions of matter accreting onto black holes. It will deploy four spacecraft, each containing a 1.6-meter diameter telescope for measuring the spectra of cosmic sources of X rays.

Optical astronomy became quantitative astrophysics more than a half-century ago when high resolution spectroscopy became routine. It then became possible to measure the speeds, composition, and physical conditions in distant astronomical objects. The X-ray band contains spectral fingerprints for all of the abundant heavy elements (carbon through zinc) and has the potential to enable exploration of hot regions of the Universe just as optical spectroscopy has done for cooler regions. As X-ray astronomy approaches its half-century anniversary, however, imaging capabilities have far outrun spectroscopy. One-third of the sources in *Chandra X-ray Observatory* deep fields are too faint for optical or X-ray spectroscopy and their nature remains a mystery.

Constellation-X is the X-ray analog of large ground-based optical telescopes such as the Keck Observatory and the European VLT, offering spectroscopic capabilities that complement the high spatial resolution of the *Chandra X-ray Observatory*. Constellation-X will provide a 25–100-fold increase in sensitivity over that of current and planned missions such as *Chandra*, ESA's *XMM*, and Japan/NASA's *Astro-E2*. This will yield a fabu-

The **Constellation-X** design achieves high throughput and reduces mission risk by dividing the collecting area across four separate spacecraft launched two at a time. An orbit at L2 will facilitate high observing efficiency, provide an environment optimal for cryogenic cooling, and simplify the spacecraft design. Use of identical off-the-shelf spacecraft buses and a parallel production line will minimize cost.

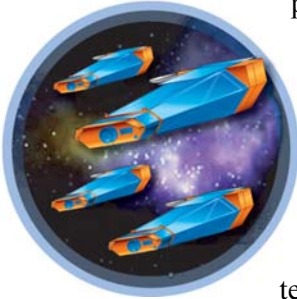

Each satellite will contain two telescope systems: one with high energy resolution ( $E/\Delta E \sim 300\text{--}3000$ ) for imaging X-ray spectroscopy (0.2–10 keV), and one with low energy resolution ( $E/\Delta E \sim 10$ ) for imaging hard X-rays (to 60 keV). The spectroscopy telescopes will have 15 arcsec resolution (half power diameter) in a 2.5 arcmin field imaged by 900-pixel quantum micro-calorimeters (with 2 eV energy resolution). They will also include a set of reflection gratings (resolution 0.05 Angstrom in first order). The hard X-ray telescopes will be the first focusing optics above 10 keV and have 1 arcmin resolution (half power diameter) in an 8 arcmin field.

All of the Constellation-X technologies are an evolution of existing, flight-proven instruments and telescopes. Substantial progress has been made in key areas of technology, including lightweight X-ray mirrors, improved energy resolution and construction of larger arrays of X-ray microcalorimeters, multilayer depositions for hard X-ray telescopes, and Cadmium-Zinc-Telluride detectors for hard X-rays.

lous harvest, making spectroscopy of faint X-ray sources routine and probing conditions close to the event horizon of black holes.

The major science objectives of Constellation-X are:

- Observe relativistically broadened emission lines from Active Galactic Nuclei to determine masses and spins of their black holes, by measuring both spectral form and its time variation. This will provide a precise clock to measure motion in the vicinity of the event horizon. The data will challenge our understanding of the behavior of matter within the framework of the general theory of relativity.
- Investigate how matter releases energy close to the event horizon. The brightness of the inner accretion disk can be inferred, to test models for energy release in accretion disks. Phenomena more exotic than accretion, such as the interaction of a spinning black hole with surrounding magnetized gas, can extract the black hole's energy of rotation. These processes can create the relativistic jets seen in many galactic nuclei, or pour tremendous power into the inner region of the accretion disk. Constellation-X will give us the first detailed picture of these remarkable processes only hinted at by previous missions.
- Trace the evolution of supermassive black holes in quasars and active galaxies. Constellation-X will use the many black holes being found by the Chandra X-ray Observatory at high redshift to trace black hole evolution over cosmic time. The X-ray band above a few keV is relatively free of obscuration and thus allows a clear view of newly born AGN even as they are shrouded by the young, dusty galaxies in which they reside. These

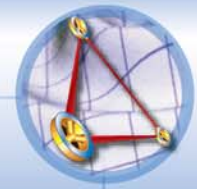

laser  
interferometer  
space antenna



constellation-x

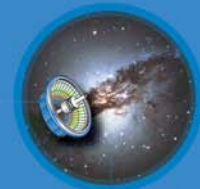

einstein probes

observations will help determine the role of these black holes in the evolution of their host galaxies.

The Constellation-X mission has been in formulation since 1996 with a focused technology development program. Constellation-X was included as a near term priority in the 1997 OSS Strategic Plan and was reaffirmed in the 2000 OSS Strategic Plan. Recent technology investments provide a clear path for future efforts that would support launches as early as 2011.

## LISA

LISA will open a new window on the Universe through the study of low-frequency gravitational waves. LISA consists of three spacecraft orbiting the Sun in a triangular configuration with a baseline of five million kilometers between spacecraft.

LISA will detect low-frequency gravitational waves by measuring the changes in the relative velocity of two approximately freely-falling proof masses within each spacecraft.

*“The bones  
of this proud woman  
answer the vibrations  
of the stars.”  
—Carl Sandburg,  
Cadenza*

**LISA** consists of three spacecraft orbiting the Sun in Earth-trailing orbits, in a triangular configuration with separations of five million kilometers. At the heart of each spacecraft are two free-flying reference masses for the detection of gravitational waves. Two 30-cm telescopes direct the beams from two cavity-stabilized lasers toward the other two spacecraft. The laser light received from the two distant spacecraft is combined with the light from the local lasers. Changes in the “beat note” between the local and distant laser reveal changes in the relative velocity of the spacecraft, the signature of gravitational waves. Combining the signals from all the pairs of spacecraft will permit detection of both of the two polarizations of gravitational waves of the waves.

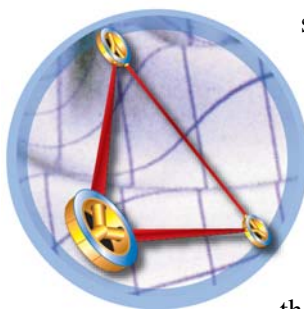

LISA will have greatest sensitivity to gravitational waves of periods of 100 to 1000 seconds, and will be able to detect gravitational wave bursts with spacetime strains as small as  $6 \times 10^{-21}$  ( $5\sigma$  all sky-average), corresponding to measuring  $3 \times 10^{-12}$  m ( $1\sigma$ ) changes in the  $5 \times 10^6$  km separation between spacecraft over each wave period. In one year of observation, LISA will detect gravitational waves from periodic sources producing spacetime strains as small as  $10^{-23}$  ( $5\sigma$  detection).

LISA will simultaneously observe a wide variety of sources from all directions in the sky. Sources will be distinguished by studying the time evolution of their waveforms. The direction of a source is revealed by the manner in which its waves' phase and amplitude are modulated by LISA's orbital motion around the Sun and its changes in orientation. LISA's ability to synthesize several interferometers with differing sensitivities to gravitational waves will enable it to discriminate isotropic backgrounds from instrumental noise.

The spacecraft use sensitive position-measuring devices to monitor the position of the proof-masses within the spacecraft (“gravitational reference units”). Micronewton thrusters will maintain drag-free control of the spacecraft about the proof masses. These two elements, viewed as the most critical to LISA's success, will be space-tested by ESA and NASA (through the ST-7 project) on the ESA SMART-2 mission, to be launched in 2006.

## THE GRAVITATIONAL WAVE SPECTRUM

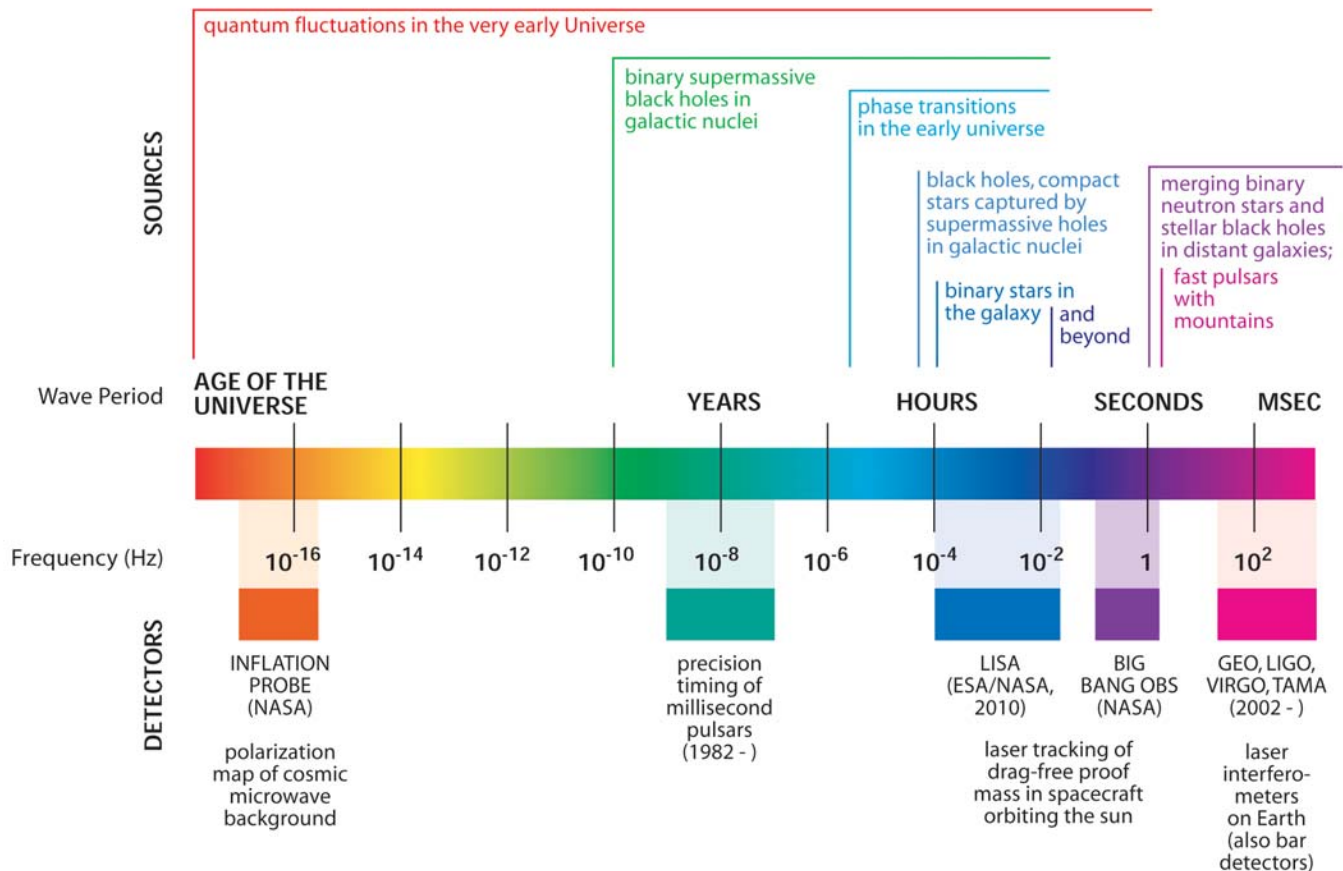

LISA will be the first instrument capable of detecting gravitational waves from already cataloged objects (several binary stars), and these will be used to calibrate LISA's performance.

Sources of gravitational waves that LISA should detect include all the thousands of compact binaries in our own Galaxy, merging supermassive black holes in distant galaxies, and the spiral descent of white dwarfs, neutron stars, and stellar-mass black holes into supermassive black holes. None of these can be detected by ground-based detectors, which are sensitive only to gravitational waves with periods in the range 0.001–0.03 seconds. In contrast, LISA measures periods between 10 seconds and a few hours. LISA may also detect violent events in the early Universe, such as phase transitions in the energy of the vacuum or in the number of dimensions, if their amplitude permits.

The major science objectives of LISA include:

- Detection of compact stars spiraling into supermassive black holes. Their orbital trajectories determine the full spacetime geometry down to the event horizon, providing the first high-precision tests of the general theory of relativity and the nature of black holes, including the famous “black holes have no hair” theorem. The desire for precise measurements of these weak signals set the sensitivity goals for LISA.

*“Primordial gravity waves would be fossils from the very instant of creation. . . . No other signal survives from that era.”*

—M. Bartusiak in Einstein's Unfinished Symphony





LIGO and other ground-based laser-interferometer gravitational wave observatories are beginning operation. With technological advances, in the coming decade these detectors may detect gravitational waves directly for the first time. Although they run on general principles similar to LISA, there are important differences. Because they are on the ground, the proof masses are not freely falling but are suspended on pendula; because they must use an artificial vacuum (the world's largest), the arms are 4 km long, rather than LISA's 5 million km. As a result they are optimized to detect waves of much shorter periods than LISA, and will therefore hear completely different sources. For example, LIGO will hear the final few minutes of radiation from merging black hole remnants of ordinary binary stars (about ten or more times the mass of the Sun). LISA will hear the final year's radiation from black holes (of masses ten to a million times the mass of the Sun) captured by supermassive (millions of solar masses) black holes in the centers of galaxies.

- Study of the role of massive black holes in galaxy evolution through the detection of black hole mergers. LISA will be able to observe for a year or more any merger of supermassive black holes in merging galaxies, essentially most of the visible Universe, with signal-to-noise ratio of over 1000. This will allow detailed observations of information-rich, complex gravitational wave forms from regions where spacetime is violently knotting and will put the general theory of relativity to a most severe test. LISA will also detect or strongly constrain the rate of mergers of intermediate mass or seed black holes, out to redshifts of 30.
- Search for gravitational wave emission from the early Universe. This will probe energy and length scales characteristic of the Universe  $10^{-15}$  seconds after the Big Bang.

LISA has been developed and is envisaged as a joint mission of NASA and the European Space Agency. LISA was included as a near-term priority in the 2000 OSS Strategic Plan. LISA is an approved European Cornerstone Mission, with a start in 2007 and launch planned for 2010 or 2011, consistent with NASA's plans. ESA has under construction a LISA technology validation mission (SMART-2) for launch in 2006. NASA is providing its own technology validation payload for launch on the ESA spacecraft through the ST-7 project of the New Millennium program.

### ***Einstein Probes***

#### **Dark Energy Probe**

The nature of the mysterious dark energy that dominates our Universe is one of the newest and most important questions facing cosmology and fundamental physics today. Probing dark energy requires measuring precisely how the expansion rate of the Universe is, to our astonishment, increasing with time. There are several plausible strategies, including: using supernovae or other standard candles as a direct test of the distance/redshift relation; probing the evolution of cosmological perturbations through observations of large-scale

*"Nature uses only the longest threads to weave her patterns, so each small piece of her fabric reveals the organization of the entire tapestry."*  
—Richard Feynman  
[Nobel Prize, 1965]

One implementation of the Dark Energy Probe involves a wide-field optical/infrared space telescope with primary aperture about 2 meters in diameter and a field of view of about 1 degree. The focal plane would consist of billion-pixel arrays of CCDs and near-infrared detectors (e.g., HgCdTe) collectively providing multicolor coverage over the range 0.4–1.7 microns. A mission of this type could search for large numbers of Type Ia supernovae in the redshift range 0.7–1.7, and provide follow-up spectroscopy and multicolor photometry for detected events. This could be accomplished by repeatedly scanning a limited region of sky about 10 square degrees. The sensitivity would be required to allow source detection down to 29th magnitude at 1 micron, and spectroscopy and precision photometry down to 25th magnitude.

Considerable technology investment would be necessary to develop reliable detector arrays of such large format. The Department of Energy has begun such development and is an interested partner in such a mission.

structure; or measuring the density of objects as a function of redshift. A mission in space is crucial to obtain high-quality data at the large redshifts ( $z \sim 0.5\text{--}2$ ) necessary to probe cosmological evolution.

The dark energy may be Einstein’s cosmological constant, now understood as an energy of the vacuum. We can use our current understanding of how quantum mechanics and gravity join to estimate what the energy density of that vacuum should be. The result is  $10^{120}$  times larger than the experimental limits! Our understanding is clearly incomplete. An experimental measurement of a small but nonzero cosmological constant would dramatically influence the search for a quantum theory of gravity. More dramatic alternative candidates for dark energy include dynamically evolving fields or even a breakdown of the general theory of relativity.

To decide which is right, we need better measurements. The *Beyond Einstein* Dark Energy Probe will:

- Accurately determine the amount of dark energy, currently believed to comprise approximately 70% of the mass-energy of the Universe. Pinning down the precise value will both verify the existence of this mysterious component beyond any doubt and, when combined with results from MAP and Planck, determine whether our Universe is flat (as predicted by inflation theories), spherical, or infinite and curved.
- Greatly increase our sensitivity to time variations in the dark energy density. Einstein’s original cosmological constant was constant in time, as the name implies. We now know that his constant is equivalent to an energy density of the vacuum. If the Dark Energy Probe shows that the dark energy density is constant in time, it will have discovered a nonzero vacuum energy, a priceless empirical clue in the quest to reconcile quantum mechanics with the general theory of relativity. If the Dark Energy Probe shows that the dark energy density varies with time, it will have discovered a new dynamical field or a failure of Einstein’s general theory of relativity—with dramatic implications for the future of our Universe.



laser  
interferometer  
space antenna



constellation-x

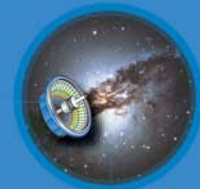

einstein probes

### Inflation Probe

The *Beyond Einstein* Inflation Probe will seek the imprint of gravitational waves on the relic Cosmic Microwave Background (CMB). These quantum waves should reveal if and how a mysterious “inflation” field stretched and smoothed our Universe. One promising approach would use a 2-meter cooled telescope located at L2, equipped with large arrays of polarization-sensitive detectors operating between 50 and 500 GHz.

Just before the Universe became neutral, electrons scattered the cosmic microwaves. This generated a pattern of polarization related to the temperature fluctuations of the CMB. Both density fluctuations and gravitons (gravitational wave quanta) produced in the very early Universe combined to determine this pattern. Temperature anisotropy studies, such as those made by COBE and MAP, cannot distinguish the density and graviton components. Fortunately, these two sources of fluctuations generate different patterns of polarization, allowing them to be separated. However, the graviton component is likely to be at least 100 times fainter than the density component, first detected in 2002 and to be mapped to high sensitivity by ESA’s Planck mission (to be launched in 2007). The Inflation Probe will:

- Map the polarization of the CMB and determine all the sources of this polarization on both large and small scales. This will provide the most precise test yet of the gravitational theory for the origin of galaxies and structure in our Universe.

Many of the *Beyond Einstein* missions require that they be located far from Earth. The L2 point is located approximately 1.5 million kilometers in the anti-Sunward direction along the line joining the Sun and the center of mass (barycenter) of the Earth-Moon system. Constellation-X and the Inflation Probe require thermal control and will orbit around L2, as does the current MAP mission. LISA’s stable five million kilometer baselines require that its spacecraft orbit the Sun in orbits trailing the Earth’s.

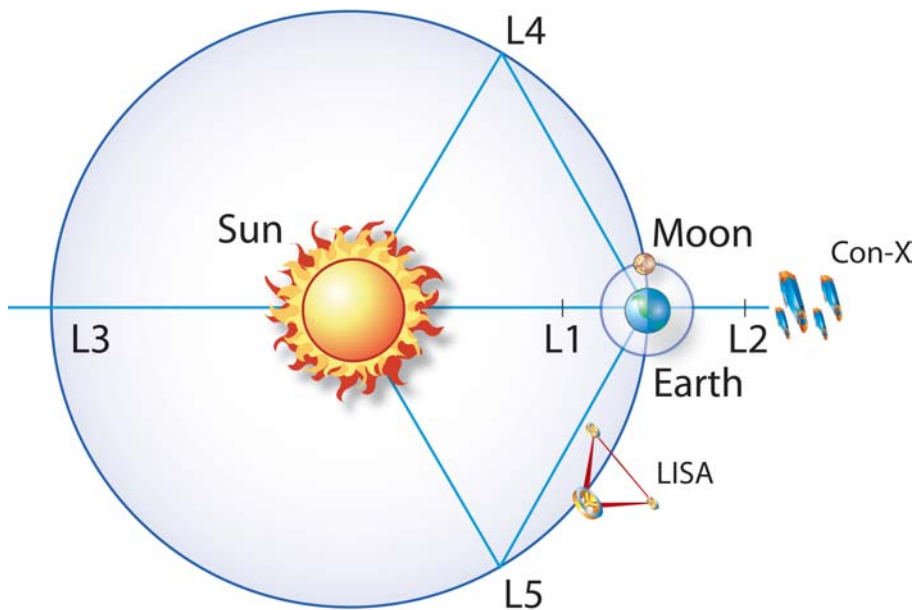

*This simulation shows the circular patterns gravitational waves as long as the Universe leave in the polarization of the cosmic microwave background.*

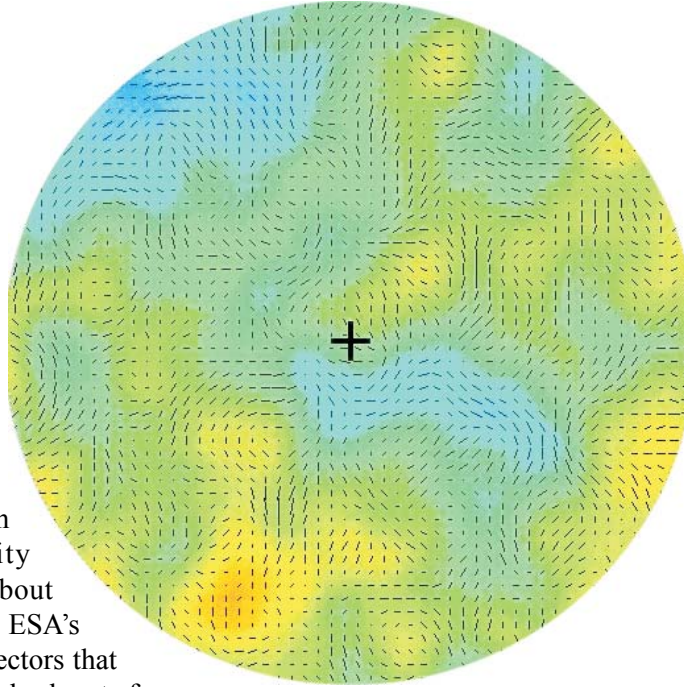

To detect the effect of gravitational waves from inflation on the polarization of the CMB will require all-sky polarization maps with sensitivity about  $1 \mu\text{K}$  per pixel, about 20–100 times better than ESA's Planck mission. The detectors that will fly on Planck are already close to fundamental quantum limits, so improvements in mapping sensitivity must come from large increases in the number of detectors and cooling the optics to reach the background limit of the CMB itself. The angular resolution of the maps must be a few arcminutes to allow the true gravitational wave signal to be distinguished from secondary sources of polarized CMB signals, such as gravitational lensing of the density component to CMB polarization. Consequently, the Inflation Probe will require at least a 2-meter class telescope, probably cooled, and equipped with focal plane arrays containing thousands of pixels. Each pixel must also be observed simultaneously from 50–500 GHz to allow astrophysical foregrounds to be subtracted. The signals from inflation are likely to be mixed with confusing foregrounds and effects from gravitational lensing, so preparatory theoretical and observational work are essential to the success of this effort.

- Search the CMB for the signature of gravitational waves from the Big Bang. This will test theories of the very early Universe, such as inflation models. It will also test physics at energies that are currently inaccessible by any other means.

### Black Hole Finder Probe

The supermassive black holes at the center of our own Milky Way and its companion, the Andromeda galaxy, are normally quiet, perhaps flaring brightly every 10 thousand years when they swallow a star from their surroundings. Even the three closest supermassive black holes now swallowing gas are hidden in galaxies that otherwise appear normal. Yet these black holes have had a dramatic effect on the formation and evolution of galaxies—and even life. The optical appearance of a galaxy usually does not advertise the presence of a black hole, or tell us what it is doing.

Did massive black holes form when galaxies formed? Did they slowly grow later? How fast are they still growing? We need a census of accreting black holes to find out.

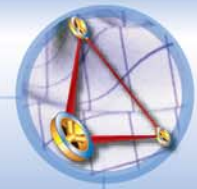

laser  
interferometer  
space antenna



constellation-x

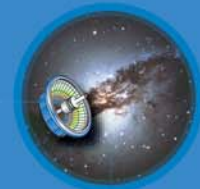

einstein probes

The Black Hole Finder Probe could be a hard X-ray survey mission, consisting of a very large-area (about 4–8 square meters) array of imaging solid-state detectors (Cadmium-Zinc-Telluride) which view the sky through wide-field coded aperture masks. The required angular resolution is about 3–5 arcmin.

To penetrate gas and dust, an X-ray Black Hole Finder Probe should be sensitive in the 10–600 keV band. To perform a reliable census, the  $5\sigma$  flux sensitivity in a 1 year survey at 20–100 keV should be  $F_{\text{lim}} \sim 5 \times 10^{-13} \text{ erg cm}^{-2} \text{ s}^{-1}$ , comparable to the flux limit of the all-sky soft (0.5–2.5 keV) X-ray survey conducted by ROSAT.

The centers of bright sources will be located to about 10 arcsec so that counterparts at optical/IR/radio wavelengths can be identified. The faintest survey sources would have 1 arcmin centroids, sufficient for identification with bright galaxies or as a finder for higher resolution instruments like Constellation-X.

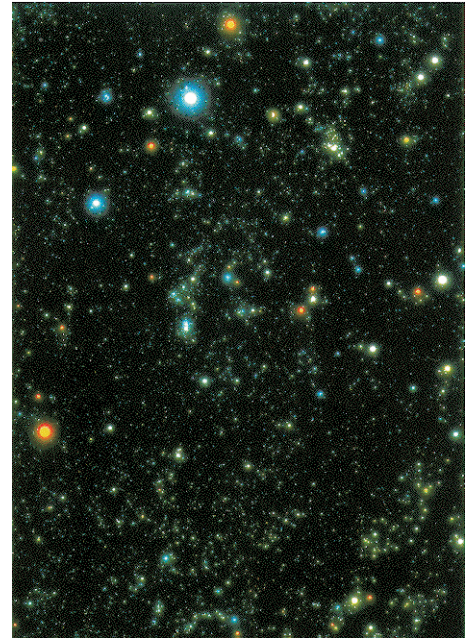

*The constellation of Orion as seen in soft X-rays by ROSAT. Besides the familiar stars, white dwarfs, supernova remnants, and accreting black holes at the edge of the Universe shine in the X-ray image*

The *Beyond Einstein* Black Hole Finder Probe will do this. It will perform the first all-sky imaging census of accreting black holes: from supermassive black holes in the nuclei of galaxies, to intermediate mass (about 100–1000 solar mass) holes produced by the very first stars, to stellar mass holes in our Galaxy.

A veil of dust and gas currently hides most accreting black holes from our view. High-energy X-rays, infrared, and radio waves can penetrate this veil. Of these, X-rays can best be distinguished from emission from stars, so one promising approach is a wide-field telescope operating in the hard X-ray band. The Black Hole Finder Probe will enable a range of studies of black holes and the extremes of astrophysics:

- Black Hole Finder Probe will survey the local Universe over a wide range of black hole obscuration and accretion rates. It can identify the most luminous obscured black holes at larger redshifts to estimate the growth rate of massive black holes. Follow-up studies with Constellation-X and eventually the Black Hole Imager will measure fundamental black hole properties (spin, mass) in the best targets.
- Black Hole Finder Probe will discover ordinary stars being torn apart as they approach black holes. It will complement LISA, which will see the gravitational waves from the initial phases of these events involving small stars, and also the capture of neutron stars and black holes too small to be torn apart.

## Einstein Vision Missions

### A Big Bang Observer

Of all waves and particles known to physics, gravitational waves interact the least. Thus they carry information to us undisturbed from the earliest moments of the Universe, when it was so dense that neither light nor neutrinos could escape. The radio waves of the cosmic microwave background escaped and began their journey to us when the Universe was 300,000 years old. The hydrogen and helium around us formed when the Universe was a few minutes old. Gravitational waves escaped on a journey to us when the Universe was less than  $10^{-35}$  seconds old. The ultimate goal of the Big Bang Observer is the direct detection of these gravitational waves.

Like electromagnetic waves, gravitational waves cover a broad spectrum. Understanding the expansion history of the Universe at the moments when quantum foam was becoming our familiar space and time requires measuring the gravitational wave relics from this era at least two widely spaced frequencies. The Inflation Probe will search for the effects of waves with periods of billions of years; the Big Bang Observer will seek a direct detection of waves with periods of 0.1–10 seconds.

At longer periods, the confusing foreground from astrophysical sources is hopelessly large. At the shorter periods at which ground-based gravitational wave detectors must operate, the expected signal from inflation becomes too weak to detect. In between, at periods of 0.1–10 second, lies a window of opportunity. In this frequency range, the primary source of foreground signals is neutron star binaries several months before coalescence, and these are few enough that they can be identified and removed. Yet the signal from the quantum foam of the early Universe is still within reach.

To reduce the risks, it may be desirable to begin with a less sensitive pathfinder mission to make the first exploration of the Universe in this gravitational wave frequency window, whose astrophysical sources are expected to include the seeds of black hole formation, the first stars, and galaxy formation.

- The Big Bang Observer has the goal of direct detection of quanta of the gravitational field created during inflation. This could give us a direct view of the creation of space and time and, in combination with results from the Inflation Probe, determine the nature of the vacuum at energies far higher than we can hope to reach with ground-based accelerators.
- The Big Bang Observer will reach this goal by identifying (and subtracting) the gravitational wave signals from every merging neutron star and stellar-mass black hole in the Universe.
- Measurement of these merger signals will directly determine the rate of expansion of the Universe as a function of time, extending the results of the Dark Energy Probe.
- The Big Bang Observer can also pinpoint gravitational waves from the formation or merger of intermediate mass black holes. These are believed to form from the first massive stars born in our Universe. They will also enable even finer measurements of the structure of spacetime around black holes than will be possible with LISA.

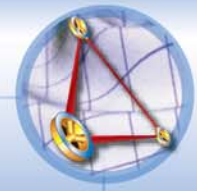

laser  
interferometer  
space antenna



constellation-x

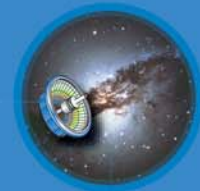

einstein probes

*“Of all the conceptions of the human mind, from unicorns to gargoyles to the hydrogen bomb, the most fantastic, perhaps, is the black hole.”*  
 —Kip Thorne in *Black Holes and Time Warps: Einstein’s Outrageous Legacy*

### A Black Hole Imager

The goal of the Black Hole Imager mission will be to image directly matter falling into a black hole, with resolution comparable to the scale of the event horizon. An angular resolution of 0.1 micro-arcsecond (a million times better than the Hubble Space Telescope) is required to do this for accreting black holes at the centers of nearby galaxies. This resolution can be achieved at high radio frequencies and at X-ray wavelengths.

A simple image, while exciting in concept, is not sufficient to study the dynamics of the inner regions. To better disentangle the complicated dynamics near the black hole will require spectroscopy to map the speed as well as position of gas as it nears the event horizon. This will require spectroscopically resolved imaging at the wavelengths of X-ray lines.

The science objectives for a black hole imaging mission are:

- Map the motions of gas in the vicinity of a black hole event horizon and compare them to predictions based on the general theory of relativity. In bright accreting black holes, the essential physical conditions can be measured via imaging spectroscopy of fluorescent features from the accretion disk’s surface, allowing a quantitative test of strong field general relativity. Constellation-X takes a first step by demonstrating time-resolved spectroscopy of relativistically broadened X-ray lines but without the imaging capability of Black Hole Imager.
- Map the release of energy in black hole accretion disks. The underlying mechanisms by which gas swirling into black holes loses energy are not well understood. A direct image of the inner disk could reveal the details of this process.
- Determine how relativistic jets are produced as well as the role of black hole spin in this process. The ultimate irony of black hole accretion is that rather than swallowing everything, somehow many black holes manage to generate relativistic jets, by mechanisms that remain a mystery. Imaging and spectroscopy will also provide direct tests of models that predict that magnetic fields extract energy from the black hole itself to power these jets.

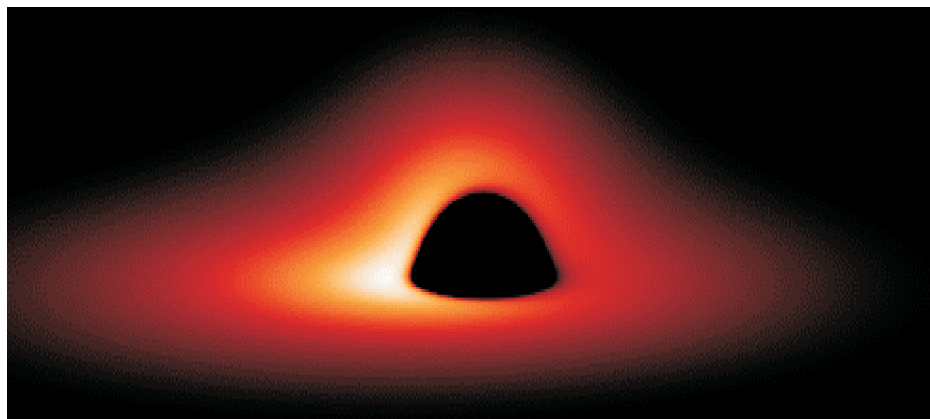

A simulated Black Hole Imager view of an accretion disk around a black hole. The bending of light rays by the black hole makes the back side of the disk appear raised.





## Chapter 3. Technology Roadmap: Beyond Einstein

The *Beyond Einstein* program cannot succeed without investment in key enabling technologies for each mission. No mission can go into full flight development before it has achieved the appropriate level of technical readiness. This requires a well-balanced technology program, in which both near- and long-term mission needs are addressed. Technology development for *Beyond Einstein* must be coordinated with other Space Science themes to identify cost sharing opportunities. Technology from early missions must be extended for later, more demanding missions. Scientists, the end-users of the technology, must be involved at all stages to ensure that mission requirements are met.

*“On a long trek, your eyes arrive first. Your feet arrive last.”*  
—African Proverb

### Einstein Great Observatory Technologies

Both Einstein Great Observatory missions have been under study for several years and have detailed technology roadmaps in place. We highlight key elements below:

#### *Constellation-X*

Constellation-X will provide X-ray spectral imaging of unprecedented sensitivity to determine the fate of matter as it falls into black holes, and map hot gas and dark matter to determine how the Universe evolved large-scale structures.

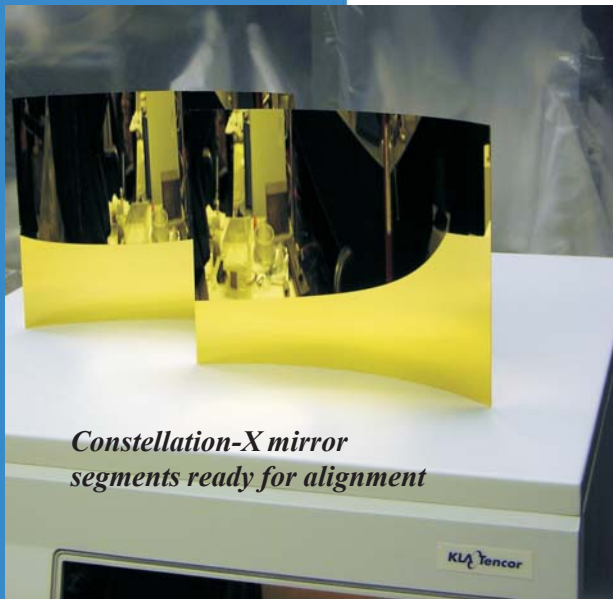

*Constellation-X mirror segments ready for alignment*

**Lightweight, grazing incidence X-ray optics.** Each of the four identical Constellation-X spacecraft will carry two sets of telescopes: (1) a spectroscopy X-ray telescope (SXT) for the low energy band up to 10 keV, and (2) three hard X-ray telescopes (HXTs) for the high energy band. Both incorporate highly nested, grazing-incidence X-ray mirror arrays, which must simultaneously meet tight angular resolution, effective area, and mass constraints. Engineering test units of both SXT and HXT mirrors are under development: glass substrates with surfaces replicated from precision mandrels for SXT and HXT, and an alternative replicated nickel shell design for HXT.

**X-ray calorimeter arrays.** Two technologies are being developed in parallel: semiconducting bolometers and voltage-biased transition-edge superconducting thermistors. Both have made substantial progress toward the required energy resolution of 2 eV. Multiple approaches to fabrication of high-quality arrays and multiplexed readout amplifiers are under development.

**Long-lived 50mK coolers.** Constellation-X requires reliable long-life first stage coolers operating at 5–10 K. The Advanced Cryocooler Technology Development Program (ACTDP) is already pursuing this goal through study-phase contracts, leading to completion of two demonstration coolers in 2005. The ultimate detector temperature of 50 mK will be reached by one of several adiabatic demagnetization refrigerator technologies currently under study.

**Grazing incidence reflection gratings.** Reflection gratings dispersed onto CCDs provide imaging spectroscopy in the 0.2–1.5 keV energy range and are similar to those flown on XMM-Newton. For Constellation-X, improvements to reduce weight and in-

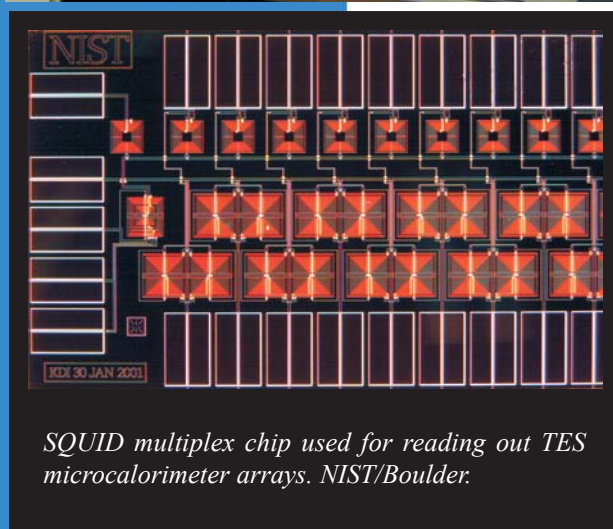

*SQUID multiplex chip used for reading out TES microcalorimeter arrays. NIST/Boulder.*



A prototype mirror segment for Constellation-X being separated from the replication mandrel.

crease resolution are under study. Novel event-driven CCDs have recently been developed that provide significant improvements in performance and robustness.

**Solid-state hard X-ray imaging detectors.** At hard X-ray energies, CdZnTe detectors provide  $< 1.2$  keV resolution and high quantum efficiency over the 6–50 keV energy range. Key requirements have been demonstrated but work is continuing on extending the response at low energies and reducing the effects of electron trapping.

### LISA

LISA will open a new window on the Universe by enabling the detection of gravitational radiation from a wide variety of astronomical systems. It consists of a triangle of reference masses in solar orbit connected by a precision metrology system. The measurement of the relative motion of these drag-free masses allows us to sense the passage of gravitational waves through the Solar System. To use the capture of compact objects to map spacetime outside of supermassive black holes sets the sensitivity requirements at wave frequencies of  $10^{-2}$ – $10^{-3}$  Hz. To measure the properties of merging pairs of supermassive black holes requires good sensitivity down at least to  $10^{-4}$  Hz.

The key technologies are those to (1) minimize external disturbances of the reference masses, and (2) precisely measure their separation.



laser  
interferometer  
space antenna



constellation-x

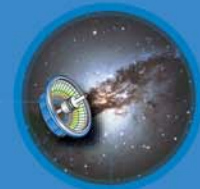

einstein probes

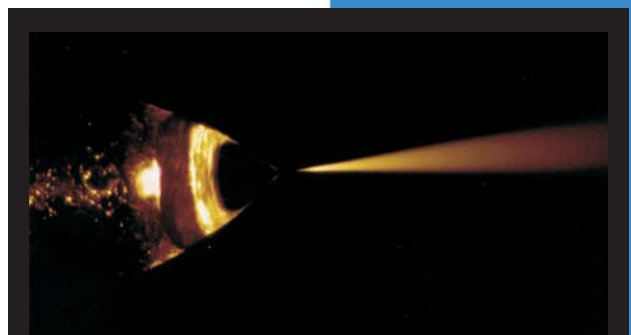

*A micronewton thruster test firing, a technology required for the LISA mission.*

Gravitational reference units of the kind shown (inset) and here undergoing testing are at the heart of the LISA mission.

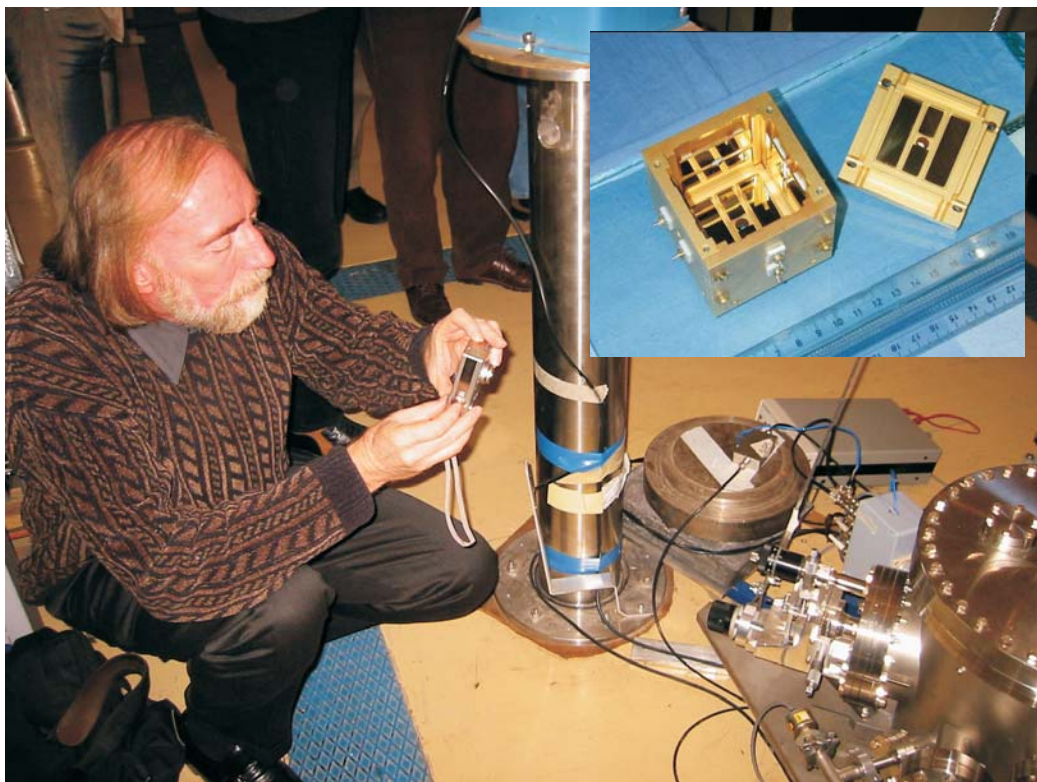

**Disturbance Reduction System.** Micronewton thrusters keep the spacecraft precisely centered about the masses. Several types which meet LISA's noise requirements have been demonstrated, and lifetime and space testing are planned. Correction signals are sent to the thrusters by gravitational reference units (GRUs), which also serve as the reference mirrors for the laser measurement system. Improvements in existing GRUs (such as those flying on the NASA/German GRACE mission) that will extend LISA's sensitivity below  $10^{-3}$  Hz are under development.

**Laser Measurement System.** LISA's sensitivity above  $10^{-3}$  Hz is set by the laser power and the measurement system. Changes in the  $5 \times 10^6$  km test mass spacing must be measured to  $10^{-12}$  m, or  $10^{-5}$  fringes. That requirement can be met by existing lasers and detection systems. But orbital dynamics lead to changes in spacecraft spacing that can create a fringe rate as large as 15 MHz. This imposes stringent requirements on laser frequency stability, telescope pointing and dimensional stability, and the phase measurement system, including ultra-stable oscillators.

**System Verification.** A validation flight is planned in June 2006 on the ESA SMART-2 spacecraft, with US participation through the New Millennium mission ST-7. This program will be an important validation of the critical disturbance reduction system components, the gravitational reference units, micronewton thrusters, and the laser interferometer to measure test mass spacing.

### Technology Development for the Einstein Probes

The Einstein Probe mission concepts will be competed in order to choose the best scientific and technical approaches to their goals. All of the measurements planned for the three Einstein probe missions are technically challenging. Readiness must be evaluated before each competition. This will require an Einstein Probe technology development

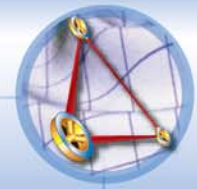

laser  
interferometer  
space antenna



constellation-x

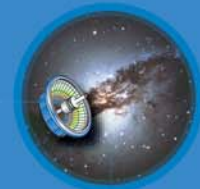

einstein probes



Einstein's general theory of relativity has a practical application which affects many people in their work and play. The U.S. Global Positioning System, or GPS, used by the military and civilians for navigation and other purposes, includes corrections for the effects predicted by relativity. A portable GPS receiver determines position by simultaneously receiving signals from atomic clocks on the GPS satellites. If relativity were not accounted for, the clocks on-board each satellite would run faster than clocks on the ground by about 38 microseconds per day. This may sound small, but the GPS system requires accuracy ten thousand times higher than this. If relativity were not taken into account, a navigational fix based on the GPS constellation would be false within minutes, and errors in positions would accumulate at a rate of about 10 kilometers each day. The whole system would be utterly worthless for navigation!

program. This program should be provided as early as possible to allow all of the promising approaches to each mission to be thoroughly vetted.

Some particular mission concepts are already being studied for each of the Probe science areas. Below we discuss the technology development required for these candidate concepts.

### ***Dark Energy Probe***

The Dark Energy Probe will be designed to perform measurements of the geometry of the Universe in the redshift range  $z = 0.7-1.7$ , where the effects of dark energy are expected to leave their most prominent signature. A particularly promising approach (and the one emphasized in the NAS CPU report) is to obtain a large sample of Type 1a supernovae to redshifts of at least  $z = 1.5$ .

A mission capable of such observations requires a wide field of view telescope with about a 2-meter diameter mirror, diffraction limited down to 1 micron, and large arrays of optical and infrared imaging detectors. All of these elements require substantial technology development. The primary mirror must have much lower cost and mass-per-unit-area and be developed faster than the HST primary. The very large detector arrays are a serious challenge: they require of order a billion pixels. At optical wavelengths, silicon-based CCDs are the obvious candidates, but the requirements exceed the capabilities of current devices. At infrared wavelengths, the gap between requirements and current devices is even larger.

### ***Inflation Probe***

The Inflation Probe aims to detect signatures of gravitational waves (with wavelengths comparable to the size of the Universe) produced by quantum fluctuations of spacetime during inflation. It will do this by measuring the weak imprint they leave on the polarization of the cosmic microwave background.

Even for optimistic models, however, this weak polarization component is very difficult to detect. It is an order of magnitude weaker than the polarization components pro-

duced by quantum fluctuations in the inflation field. The sensitivity required is roughly 20–100 times that of the HFI focal plane detector on *Planck*. Achieving such a vast increase in sensitivity requires significant advances: e.g., large arrays of polarization-sensitive detectors with frequency multiplexing from 50–500 GHz. Other technical challenges include the need for cold optics at low cost and 100 mK detector operating temperatures with very stable temperature control.

### ***Black Hole Finder Probe***

The Black Hole Finder Probe will conduct a wide field survey of black holes. It is likely to operate at hard X-ray/soft gamma-ray energies, where radiation emitted from these objects can penetrate any surrounding veil of gas and dust.

Such a survey instrument would need to be sensitive over an energy range of about 10–600 keV, and to have angular resolution less than 5 arcmin. Since reflective optics provide very limited fields of view at these high energies, the telescope must use coded aperture imaging. To provide sufficient sensitivity, the detector plane must have an area of several square meters with millimeter-sized pixels to provide the required angular resolution. A CdZnTe detector array seems the most likely candidate, but there remain technical challenges. Other technology problems arise in the areas of mask fabrication and data acquisition at high trigger rates.

## **Technologies for Beyond Einstein Vision Missions**

The ultimate visions of the *Beyond Einstein* program stretch well beyond what will be accomplished with either the Einstein Great Observatories or the Einstein Probes. Although detailed designs for successor missions would be premature, it is important to begin addressing some of the anticipated technology needs.

### ***Big Bang Observer***

The ultimate goal of a Big Bang Observer is to directly observe gravitational waves with sufficient sensitivity to observe the background due to the quantum fluctuations during inflation. This must be accomplished in the face of a strong foreground of gravitational waves produced by all the binary stars and black holes in the Universe. Source-by-source removal of this foreground is practical at wave periods of 0.1–10 seconds.

To separate these foreground sources requires extraordinary sensitivity and angular resolution. One possible solution consists of four separate interferometers, each including three spacecraft separated by 50,000 km. These would be spaced in a triangle around the earth's orbit about the Sun (separations

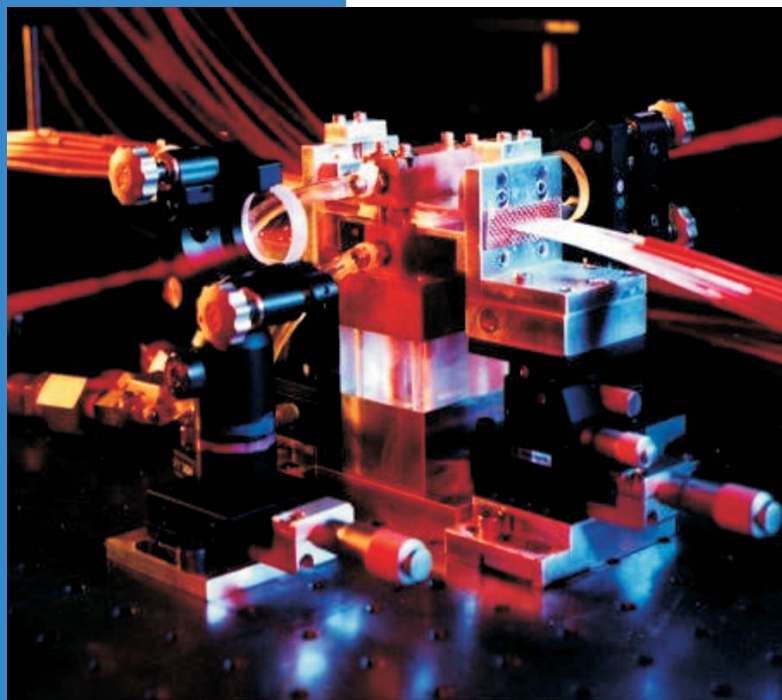

The Big Bang Observer will require powerful space-qualified lasers. Here a 125 W laser (scalable to 30 kW) is shown under test.

### Strategic Technology Infusion Flow - Gravitational Wave Missions

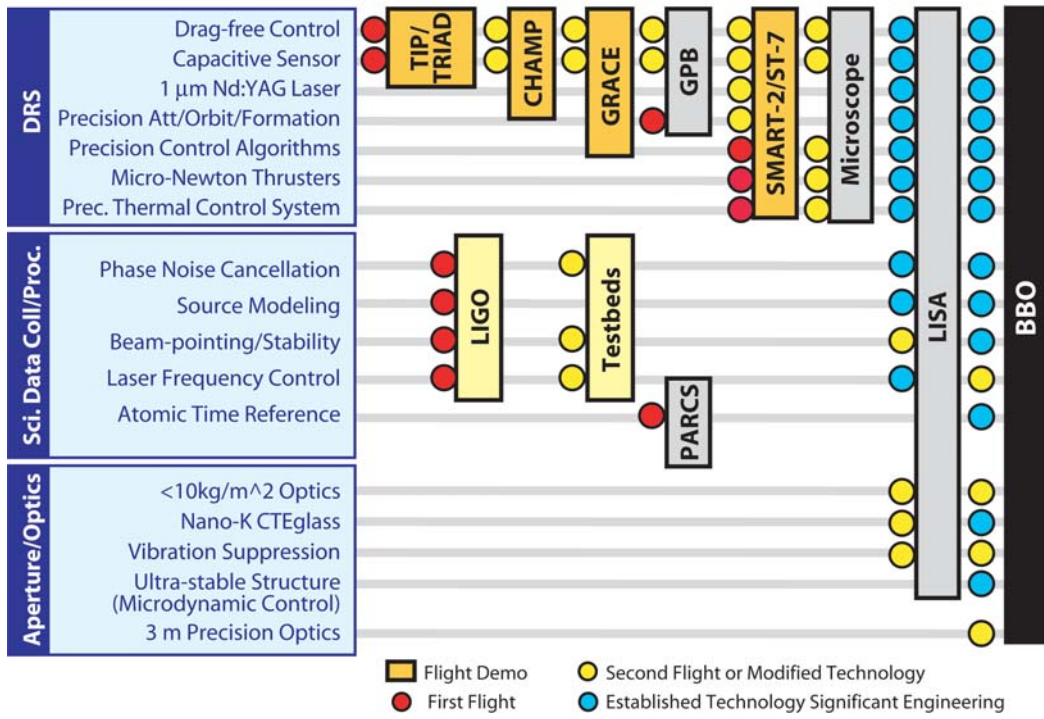

laser interferometer space antenna



constellation-x



einstein probes

of 1.7 times the Earth-Sun distance), with two interferometers sharing one apex for independent correlation. Such a configuration imposes many technical challenges, including:

**Strain Sensitivity.** A significant improvement in strain sensitivity, about 10,000 times better than that of LISA is needed. This will require advances in mirror fabrication, laser power and stability, phase measurement, and instrument pointing.

**Acceleration Noise.** A gravitational reference sensor with acceleration noise performance 100 times lower than that planned for LISA is required.

This gravitational wave frequency band will not have been previously explored. To provide scientific guidance and to reduce the risk associated with making such large technical advances in one step, it would be desirable to first fly a pathfinder mission with fewer spacecraft and more modest improvements on LISA’s technology.

**Black Hole Imager**

The goal of the Black Hole Imager is to enable direct imaging of the distribution and motion of matter in the highly distorted spacetime near the event horizon of a black hole. This will require angular resolution better than 0.1 microarcsecond—a million times better than Hubble Space Telescope. An X-ray interferometer is naturally matched to this task, since accreting black holes are expected to have a high surface brightness in X-rays, and this, coupled with the short wavelength, allows an instrument of relatively modest aperture and baseline to be used.

An X-ray interferometer with 0.1 microarcsecond (μas) resolution poses technical challenges. At wavelengths near 1 nm, the required baselines are about 1 km, and focal

### Strategic Technology Infusion Flow - Black Hole Imager

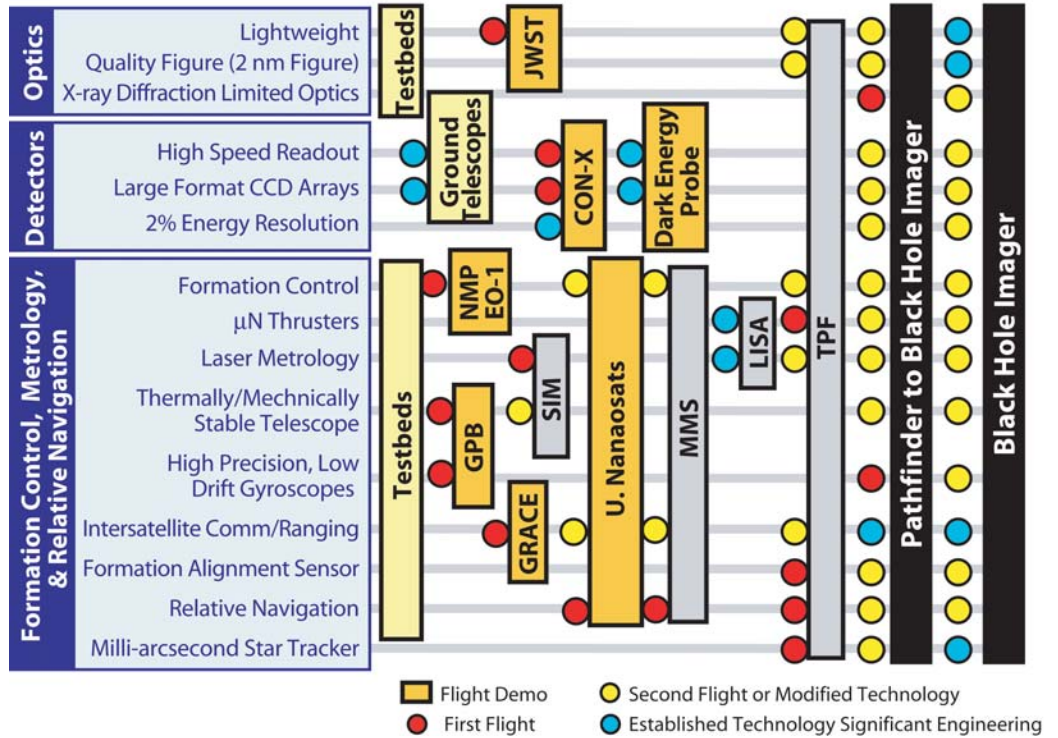

distances must be 1,000–10,000 km to obtain reasonable detector scales. This means that separate spacecraft are needed with highly controlled formation flying. Nominal requirements are: position accuracy of a fraction of a nanometer, angles known to 0.1  $\mu$ s, and optical surfaces figured to 2.5 nm.

The Black Hole Imager makes use of X-ray interference (lower left), recently demonstrated in the laboratory.

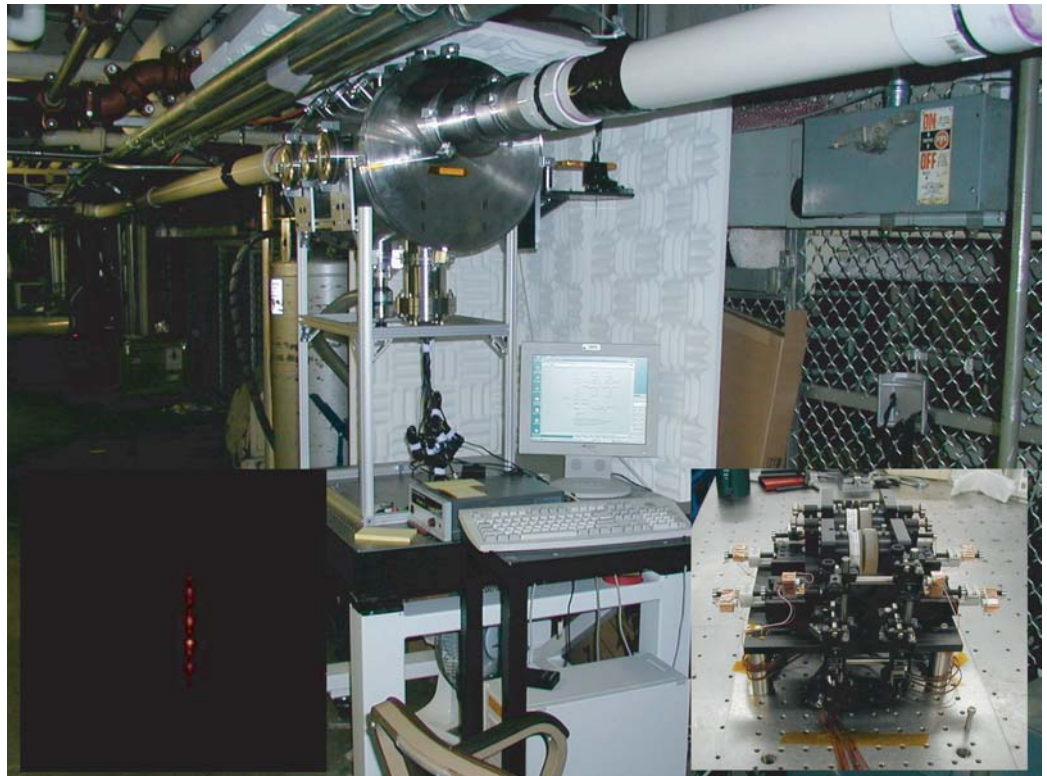

**Pointing.** Sensing and controlling the orientation of the line joining the centers of the reflector and detector spacecraft is probably the greatest technology challenge, one shared with the Big Bang Observer and NASA's *Terrestrial Planet Finder* mission. An advanced form of gyroscope may be needed.

**Mirror figuring.** Though grazing incidence relaxes the required surface figure accuracy, extending current fabrication techniques to panels of the size required for this mission will not be trivial.

To reduce the risks associated with making such large technical advances as these in one step, it would be desirable to first fly a pathfinder mission with angular resolution a hundred times less fine.



## Chapter 4. Research and Analysis

### Theory

The NAS decadal survey *Astronomy and Astrophysics in the New Millennium* recognized theoretical studies as a central component of modern mission technology development. Theoretical studies include conceptual and analytical theory, development of software technologies supporting data exploration, astrophysical simulations, and combinations of these. That survey recommended that support for theory be explicitly funded as part of each mission funding line, because detailed modeling connecting the elements of a mission to the system under investigation is critical to design and even to conceive successful and cost-effective missions. Rigorous modeling is an important factor in reducing mission risk and evaluating competing mission strategies, and simulations can vividly demonstrate mission goals. *Beyond Einstein* explores to the boundaries of foundational knowledge as well as to the boundaries of spacetime, so detailed and quantitative theoretical studies are indispensable, starting with the earliest design phases.

Some examples of necessary theoretical studies supporting *Beyond Einstein* are:

- Constellation-X. Models of relativistic hydrodynamic flows in accretion disks, including radiative transfer models, leading to simulated, time-dependent spectra.
- LISA. Studies and simulations of signal extraction in the presence of multiple, overlapping signals; numerical relativity, aimed at accurate calculation of predicted gravitational waveforms for the whole range of merging and orbiting systems; astrophysical modeling and simulations to connect binary population predictions with other data sets.
- Inflation Probe. Theoretical studies of early Universe cosmology, including tensor and scalar mode predictions and their connection with fundamental theory; simulations of polarization effects, including the contamination effects of astrophysical foregrounds and gravitational lensing; development of optimal statistical signal extraction techniques.
- Dark Energy Probe. Theoretical studies of Type Ia supernovae and other candidate systems for calibrating cosmic distances, including simulations of statistical effects of gravitational lensing by dark matter; realistic simulation of various competing techniques (e.g., galaxy clusters, quasar clustering) to facilitate evaluation of most precise and reliable methods. Theoretical work combining anticipated new results from particle theory and experiment with cosmology will be important to optimize the probe to test theories of dark energy.
- Big Bang Observer. Early Universe cosmology and phenomenology of quantum gravity, string theory, and brane world models; models of coalescing white dwarf and neutron star binaries and populations in the 0.1 to 1 Hz range.
- Black Hole Imager. Comprehensive simulation of black hole environments, including electromagnetic field interactions with flows and the spacetime metric, and radiative transfer over many decades of dynamic range.

“What is now proved  
was once only  
imagin’d”  
—William Blake

“The purpose of  
models is not to fit the  
data but to sharpen  
the questions.”  
—Samuel Karlin

## Supporting Ground-Based Research and Analysis

*Beyond Einstein* missions also require specialized supporting ground-based programs. As in the case of theory, these studies should start early in the program since they will influence the optimization of the mission design parameters. In the case of the Einstein Probes, a broad effort is needed since even the mission concept will be competed.

The Inflation Probe, if it is based on microwave background anisotropy polarization, will require new generations of polarization-sensitive detectors, excellent control of systematic effects, and a thorough understanding of astrophysical foregrounds. Ground-based cosmic microwave background polarization experiments will be essential preparation for the Inflation Probe, both for testing of new technology, investigation of observing strategies and systematics, and for providing data to test new analysis techniques. Detector technology for COBE, MAP, and Planck was a direct product of ground-based and sub-orbital programs. In the same way, a strong ground-based program is an essential precursor to the Inflation Probe.

Whatever technique is adopted, the Dark Energy Probe will require ground-based data of unusual uniformity, quality, and completeness. If Type Ia supernovae are employed, space studies must be supported by detailed and precise ground-based spectra and photometry of a large, uniformly selected sample of relatively nearby supernovae. This is required both as a calibrating set for the high-redshift Hubble diagram and as a statistical control sample to study the systematic correlations of supernova properties—the generalization of the one-parameter fits to light curve shape currently being used. Similar foundational studies are needed for other candidate techniques for the Dark Energy Probe. Programs supporting ground-based studies of this type are already underway with funding from the National Science Foundation and the Department of Energy.

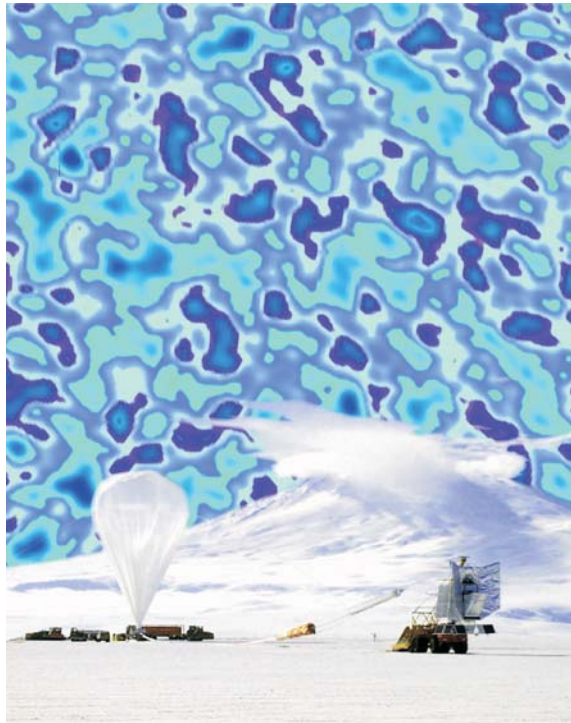

The BOOMERanG measurements performed under the supporting research and analysis program were obtained from suborbital balloon flights and provided key measurements on the shape of the Universe from observations of the cosmic microwave background.

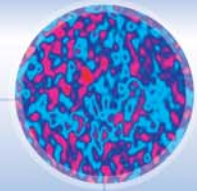

big bang

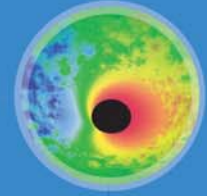

black holes



dark energy

## Chapter 5. Education and Public Outreach

### Education, Outreach, and the Public Mandate

“You do not really understand something unless you can explain it to your grandmother.”  
—Albert Einstein

The *Beyond Einstein* program offers an unparalleled opportunity to involve the public and the education communities in the excitement of cosmic exploration. Its major science themes are integrated into NASA’s education priorities and goals. Its quest to investigate the Big Bang, matter and spacetime near black holes, and the expansion of the Universe will inspire the next generation of explorers, including students, educators, and the general public. In addition, the science and technology of these missions provide opportunities to cultivate the next generation of scientists and engineers. This latter goal, consistent with NASA’s Education priorities, comes at a critical time, when the number of American-born scientists and engineers is dwindling. Further, the science and technology encompassed by these missions will lend themselves to providing educators with teaching tools to utilize in their science and math classes. The missions and research programs in *Beyond Einstein* will bring significant resources to this educational challenge, so that all Americans can share in the asking and answering of some of the most basic and far-reaching questions about the Universe. Finally, addressing questions about the origin of the Universe and the nature of black holes will engage the public in sharing in our exploration. The public’s eagerness to share this adventure is reflected in part by the many Hollywood movies, television series, bestselling books, and popular articles that draw on the themes in *Beyond Einstein*.

The missions and probes in the *Beyond Einstein* theme offer unique educational opportunities. For example, the origin and nature of the Universe is considered an important part of science education and of cultural literacy generally. Students yearn for a deeper



understanding of how the Universe originated. Current classroom materials developed for “Live from the Edge of Space and Time” help students explore the size and shape of the Universe and the nature of the expansion of the Universe. New results from MAP, LISA, and the Inflation Probe will extend this by developing a comprehensive and coordinated set of materials with which teachers and students can examine evidence for the Big Bang and trace the underlying idea that scientific inquiry can address even the most ancient and difficult questions. These are necessary topics for the education community as they are included in the *National Science Education Standards*, which also form the basis for most state education frameworks.

Similarly, black holes are a touchstone for a wide range of topics in the math and science curriculum, as well as inspiring great interest among students. *Beyond Einstein’s* quest to study matter and spacetime near a black hole provides opportunities to discover unexpected phenomena that occur in these extreme conditions. Black holes are cited in the *Benchmarks for Science Literacy*—published by the American Association for the Advancement of Science and widely used along with the *National Standards*—as an excellent way to introduce students to the important idea that “under extreme conditions the world may work in ways very different from our ordinary experience, and that the test of scientific theory is not how nearly it matches common sense, but how well it accounts for known observations and predicts new ones that hadn’t been expected.” The *Benchmarks* mandate that by the end of 12th grade, “students should know that . . . many predictions from Einstein’s theory of relativity have been confirmed on both atomic and astronomical scales. Still, the search continues for an even more powerful theory of the architecture of the Universe.” The very nature of *Beyond Einstein* provides the means for fulfilling these objectives.

Another crucial area of opportunity is technology education. Many states now require technology education in middle school, and science museums across the country are building “Current Science and Technology Centers” to address the public’s interest in new technologies. The fantastic requirements of a mission like LISA—which will measure an object being jostled by less than the width of an atom—provoke the kind of excitement and questioning that draws young people into science and technology in the first place, as well as providing avenues for educators to bring concepts from engineering and technology into the classroom.

Current efforts in NASA’s Office of Space Science education program includes linking current space science content with education science content. It matches what scientists regard as fundamental results with the appropriate education curriculum in a manner that is more specific than those embodied in the standards. The missions of *Beyond Einstein* address the space science content in the origin of the Universe, black holes, binary systems, and endpoints of stellar evolution, among others, and thus through this concept map are readily linked to the education curriculum. In addition, these missions will be at the forefront of updating this science content, thereby impacting what is included in the science curriculum. Additional efforts in NASA’s Office of Space Science education program identify education science curriculum needs with available NASA education materials, thus allowing education and public outreach developers to identify where materials are needed. The *Beyond Einstein* missions will fill many of the needs for materials about the Big Bang, gravity, and the expansion of the Universe.

Among the hallmarks of *Beyond Einstein’s* approach to education and outreach are: the participation of space scientists at all levels of outreach; an emphasis on the diversity of people and cultures who contribute to the questions and the quest; an emphasis on professional development of pre-service and in-service teachers; the link between technology and the advancement of science; and an emphasis on the nature of scientific in-

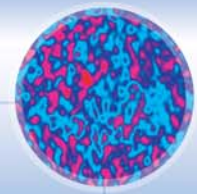

big bang

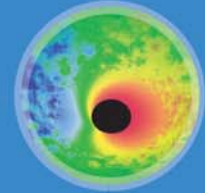

black holes



dark energy

*The show, Journey to the Edge of Space and Time, increased attendance at planetariums in Boston and Philadelphia by more than 20%.*

The Starchild Web site for elementary students was one of the first winners of the Webby award for Education.

(<http://starchild.gsfc.nasa.gov>)

Imagine the Universe!, a Web site on Beyond Einstein themes, has been visited by millions of Americans.

(<http://imagine.gsfc.nasa.gov>)

“Thank you for such an educational site for children. I am a homeschooler and this is so comprehensive.”  
—Mrs. D.

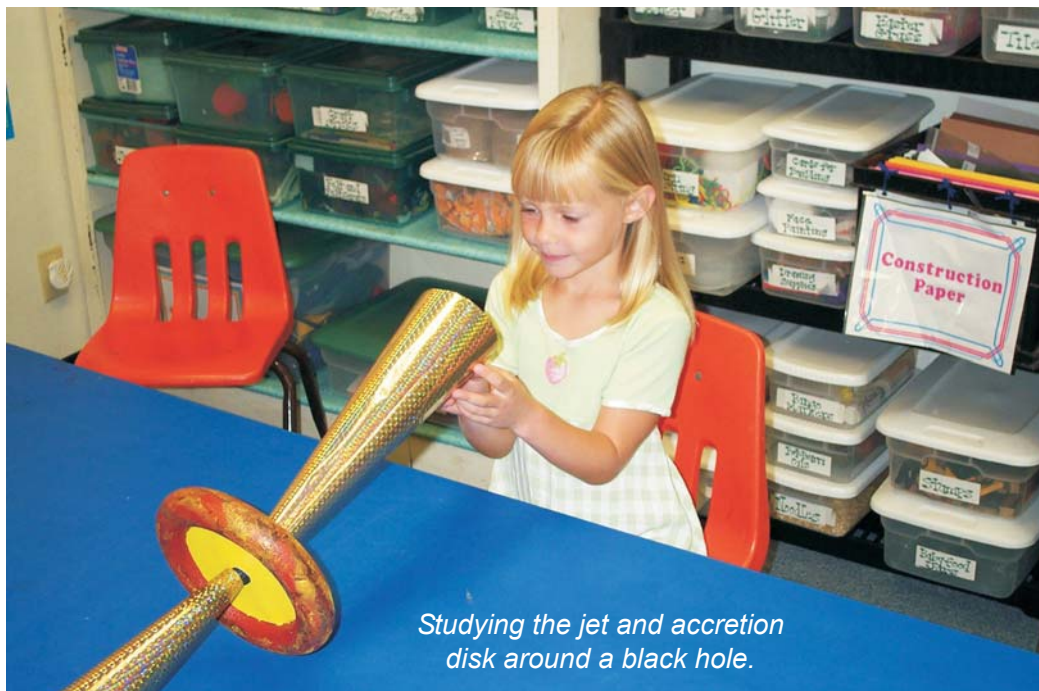

Studying the jet and accretion disk around a black hole.

quiry. Education and public outreach programs in the past have seen great success in telling the human side of planning, building, and launching the great missions of science exploration. The pioneering missions in *Beyond Einstein* offer opportunities to see the impact of dealing with profound questions on those who work toward the answers. Links to teachers will be established early in the *Beyond Einstein* program so that the educational component can grow with the program, and students, teachers, and the general public can participate in its thrill.

*Beyond Einstein's* education efforts are part of a comprehensive initiative coordinated by the Office of Space Science. Thanks to an efficient network of partnerships throughout the education and outreach communities, OSS products and programs now reach virtually every avenue of public interest, including the nation's schools, science museums and planetariums, media outlets, after-school programs, libraries, and community groups. Special emphasis is placed on the pre-college years, including middle-school and the lower grades, times when lifelong attitudes towards science and science literacy are developed. Outreach programs for the *Beyond Einstein* theme will build on these existing partnerships and programs.

Educational products and programs on the science themes of *Beyond Einstein* are expected to be extremely popular, as they have been in the past. For example, the television shows and educational materials for “Live from a Black Hole” and “Live from the Edge of Space,” reached an estimated five million students. Either directly or indirectly, NASA materials related to the *Beyond Einstein* theme now provide much of, and soon the majority of, all materials on these subjects in our nation's schools.

Finally, *Beyond Einstein* missions will weave an ongoing story that is considered one of the most compelling in all science—a story that will form the raw material for museum exhibits, planetarium shows, radio programs, and other media outlets. We know that the public clamors to be involved in this story, because they vote with their feet and their pocketbooks: more than 120 million Americans visited science museums and planetariums in 2001—and the science themes included in *Beyond Einstein* remain favorites among museum goers.

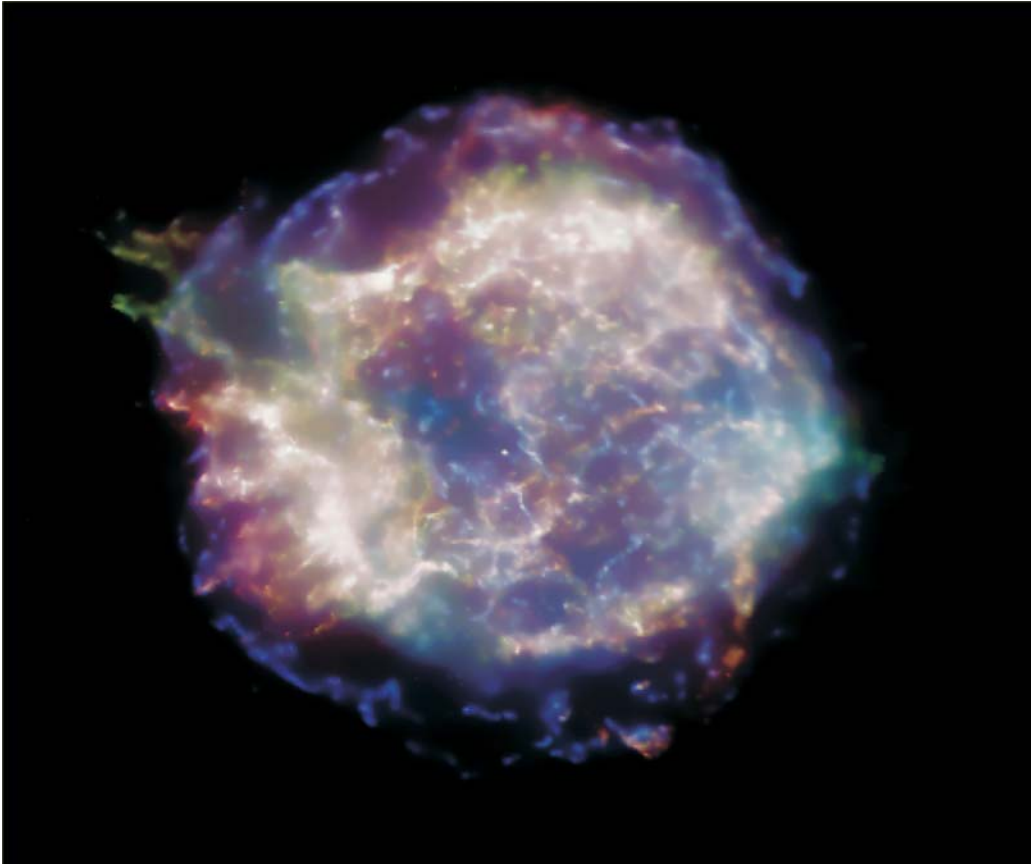

Chandra X-ray Observatory image of the gas remnant of a supernova explosion, Cassiopeia A. Most of your body mass comes from elements created in stars; exploding stars like this one are the sources of the iron in your blood, the calcium in your bones, and the oxygen you breathe.

## **Part II**

# **Cycles of Matter and Energy**

## Cycles Science Objectives and Research Focus Areas

*NASA Agency Goal: Explore the Solar System and the Universe beyond.*

### Science Objective 4. Explore the cycles of matter and energy in the evolving Universe.

Research Focus Area 8. Determine how, where, and when the chemical elements were made.

Research Focus Area 9. Understand how matter, energy, and magnetic fields are exchanged between stars and the gas and dust between stars.

Research Focus Area 10. Discover how gas flows in disks and how cosmic jets are formed.

Research Focus Area 11. Identify the sources of gamma-ray bursts and cosmic rays.

### Science Objective 5. Understand the development of structure in the Universe.

Research Focus Area 12. Discover how the interplay of baryons, dark matter, and gravity shapes galaxies and systems of galaxies.

Research Focus Area 13. Explore the behavior of matter in extreme astrophysical environments.

Research Focus Area 2. Determine the size, shape, age, and energy content of the Universe.

Research Focus Area 4. Determine how black holes are formed and how they evolve.



active galactic nuclei



dusty galaxies



supernovae

*The intellectual challenge for the SEU theme encompasses the birth, death, lifecycles, and interrelationships between galaxies, stars, black holes, and the gas, dust, and radiation fields that permeate the space between them.*



## Chapter 6. Science Objectives

### A Rich and Diverse Universe

The Universe is a dynamic, evolving place—the cosmic equivalent of the web of biological and physical interactions that shape our own planet. The SEU portfolio includes missions that have revolutionized our understanding of the web of cycles of matter and energy in the Universe.

To understand the structure and evolution of the Universe, we use tools from throughout the electromagnetic spectrum to explore diverse astrophysical venues. The Chandra X-ray Observatory has been notable in this regard, opening our eyes to the richness of the X-ray Universe, as the Hubble Space Telescope has done for the optical part of the spectrum and the Space Infrared Telescope Facility will soon do for the infrared.

The Universe is governed by cycles of matter and energy, an intricate series of physical processes in which the chemical elements are formed and destroyed, and passed back and forth between stars and diffuse clouds. It is illuminated with the soft glow of nascent and quiescent stars, fierce irradiation from the most massive stars, and intense flashes of powerful photons and other high energy particles from collapsed objects. Even as the Universe relentlessly expands, gravity pulls pockets of its dark matter and other constituents together, and the energy of their collapse and the resulting nucleosynthesis later work to fling them apart once again.

The aim of the SEU theme is to understand these cycles and how they created the conditions for our own existence. To understand how matter and energy are exchanged between stars and the interstellar medium, we must study winds, jets, and explosive events.

*“All of us are  
truly and literally  
a little bit of stardust.”  
—William A. Fowler  
[Nobel Prize, 1983]*

#### *From gas to stars and back again . . .*

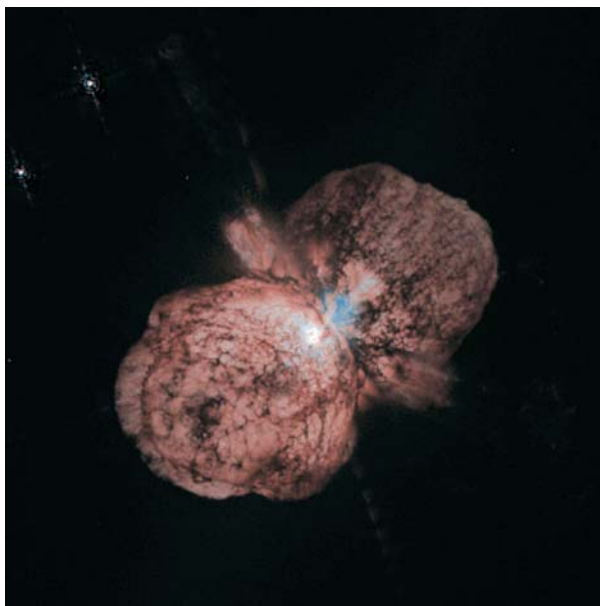

A huge, billowing pair of gas and dust clouds is captured in this Hubble telescope picture of the super-massive star Eta Carinae. Eta Carinae suffered a giant outburst about 150 years ago and now returns processed material to the interstellar medium.

## SEU CYCLES OF MATTER AND ENERGY

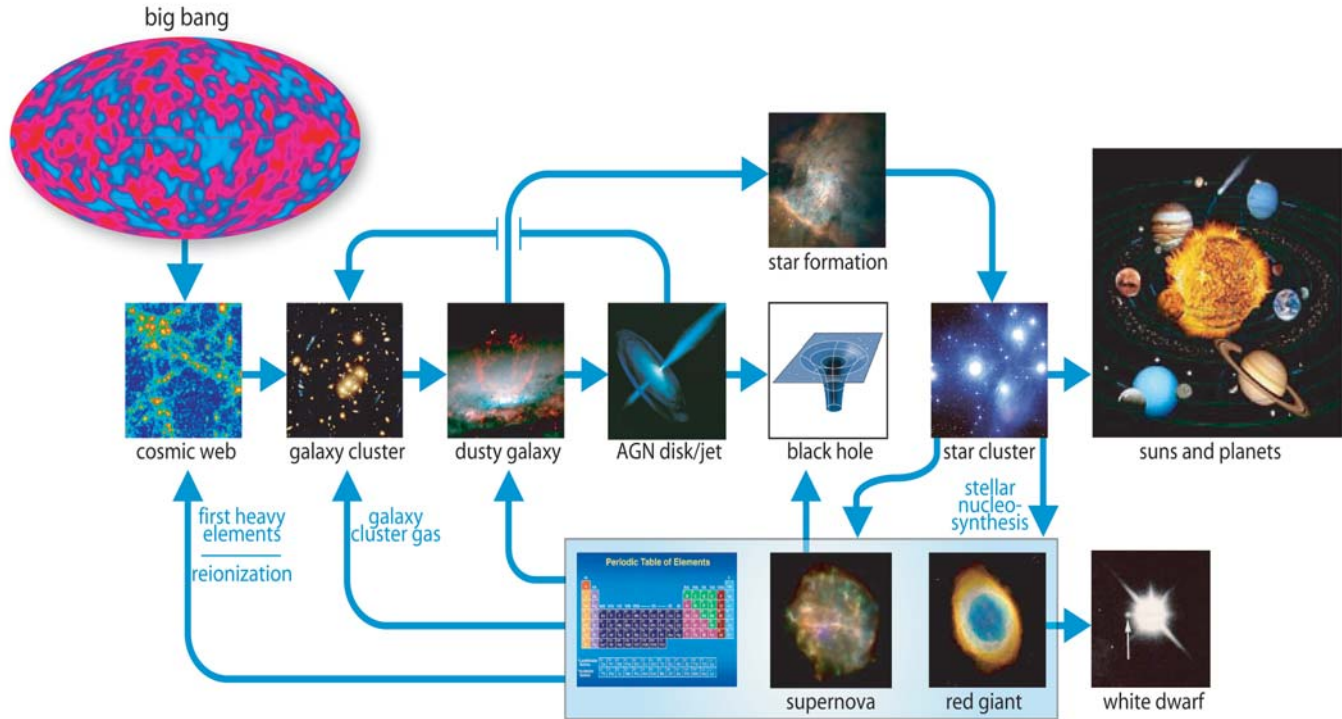

Interdependent cycles of matter and energy determine the contents of the Universe. The aim of the SEU theme is to understand these cycles and how they created the conditions for our own existence.

Our task includes uncovering the processes that lead to the formation of galaxies and their dark matter halos. Finally, we seek to understand the behavior of matter in extreme environments: crushing neutron stars and the sources of gamma-ray bursts and the highest-energy cosmic rays.

The missions of *Beyond Einstein* can address some of the goals of the *Cycles of Matter and Energy* program. But to unravel the interlinked cycles, future missions with additional capabilities are needed.

- To decipher the flows of gas and energy in the first galaxies: a cryogenic, large aperture infrared observatory.
- To uncover how supernovae and other stellar explosions work to create the elements: an advanced Compton telescope and a hard-X-ray spectroscopic imager.
- To map the “invisible” Universe of dark matter and gas expelled during the birth of galaxies: a large-aperture telescope for imaging and spectroscopy of optical and ultraviolet light.
- To measure the motions of the hottest and coldest gas around black holes: a radio interferometer in space.

- To see the birth of the first black holes and their effect on the formation of galaxies, and to probe the behavior of matter in extreme environments: a very large aperture arc-second X-ray imaging telescope.
- To determine the nature and origin of the most energetic particles in the Universe today: a mission to track them through their collisions with the Earth.

## What We Have Learned

The cycles that we seek to understand are driven by stars and galaxies. Before describing how we plan to proceed, we briefly review what we have learned so far about these, the principal actors.

### *Stars: Engines of Change in an Evolving Universe*

For a star, mass is destiny—the low mass stars slowly fuse hydrogen into helium, while massive stars burn fiercely for a brief cosmic moment. Stars about one-half the Sun’s mass or less have a lifetime that is at least as long as the present age of the Universe. The oldest of these stars show us that our Galaxy once lacked the heavy elements out of which planets and people are made. Stars of later generations, like the Sun, inherit a legacy of atoms created by short-lived massive stars when the Universe was young.

Massive stars create new elements—oxygen, calcium, iron—and return them to space through stellar winds. At the end of these stars’ lives, fierce fires forge elements heavier than iron and expel them in the huge explosions called supernovae. The accumulated products of these events become the material for new stars that form in the densest interstellar regions, and which also serve as cradles for organic molecules related to life. Lower-mass stars evolve more sedately. As they run out of hydrogen fuel, they slowly expand to become large, cool “red giant” stars. These stars exude strong “stellar winds” that are the major source for interstellar carbon, oxygen, and nitrogen. Our Earth, and our bodies, are formed from the chemically processed ejecta of all these stars.

### *Galaxies: Bringing it all Together*

These stars congregate, by the billions, in billions of galaxies, which come in a wide range of sizes and shapes. To explain this rich variety, SEU missions will trace their evolution from their origins in the early Universe to the intricate systems we find today.

We know that when the Universe was a much younger and more violent place, super-massive black holes were gorging themselves in a natal feeding frenzy as galaxies formed around them. The signposts of this process are the quasars

*Stars are the factories for new elements in the Universe and, by the energy that they deposit there, mix the raw material for succeeding generations. The SEU theme is committed to mapping the processes by which these stellar factories build up the Universe.*



### *Fountains of new elements spraying into the Universe . . .*

This HST snapshot of the galaxy NGC3079 reveals dramatic activities in its core. Gaseous filaments at the top of a hot bubble of gas are being expelled into intergalactic space. Eventually, some of this gas will rain down on the disk to form new generations of enriched stars.

**National Priorities.** The National Academy of Sciences decadal survey *Astronomy and Astrophysics in the New Millennium* (Astronomy and Astrophysics Survey Committee, 2001) has endorsed several missions that support the science objectives of Cycles of Matter and Energy. These missions are the Gamma Ray Large Area Telescope (GLAST), the Single Aperture Far Infrared (SAFIR) observatory, the international Advanced Radio Interferometer between Space and Earth (ARISE), and the Advanced Cosmic-ray Composition Experiment for Space Station (ACCESS). The survey has also endorsed the Ultra Long Duration Balloon (ULDB) program, the laboratory astrophysics program, and the theory program.

and active galactic nuclei. Even relatively quiet galaxies like our own have massive black holes lurking at their centers. What role did black holes play in the evolution of galaxies?

It is a daunting challenge to try to understand events that happened billions of years ago in faraway places. But we can do this in at least three ways. We can measure the ages of stars in nearby galaxies to reveal their history of stellar births. We can study nearby galaxies still under construction today. And we can use powerful telescopes as time-machines to see the past directly: as we peer farther out into space, we see back in time.

### The Next Steps: The Space Astronomy Imperative

Space-based telescopes are uniquely suited to uncovering the cycles of matter and energy in stars and galaxies. Different parts of these cycles produce radiation of different wavelengths. On Earth, we are restricted to peering at the cosmos in the narrow ranges of wavelength that our atmosphere happens to let through. From space, we can choose our observation wavelengths based on their information content. The isolation of a space satellite also allows more stable and precise pointing, giving the clearest view of the Universe. It also allows for cooling the telescopes, which can vastly increase the sensitivity at some wavelengths.

#### *Of New Stars and New Galaxies*

We are just beginning to learn how star formation takes place locally, enabling us to look for its signatures in the distant Universe. The Stratospheric Observatory for Infrared Astronomy (SOFIA) and new space observatories such as the Space Infrared Telescope Facility (SIRTF) and ESA's Herschel Space Observatory will make these first attempts.

#### *Glimmers of secrets through the murk . . .*

The infrared transparency of a nearby dust enshrouded galaxy (Cen A) is illustrated by comparing an HST optical image (left) with a near infrared NICMOS image of the nuclear region (inset at right). The center of this galaxy is clearly revealed at infrared wavelengths.

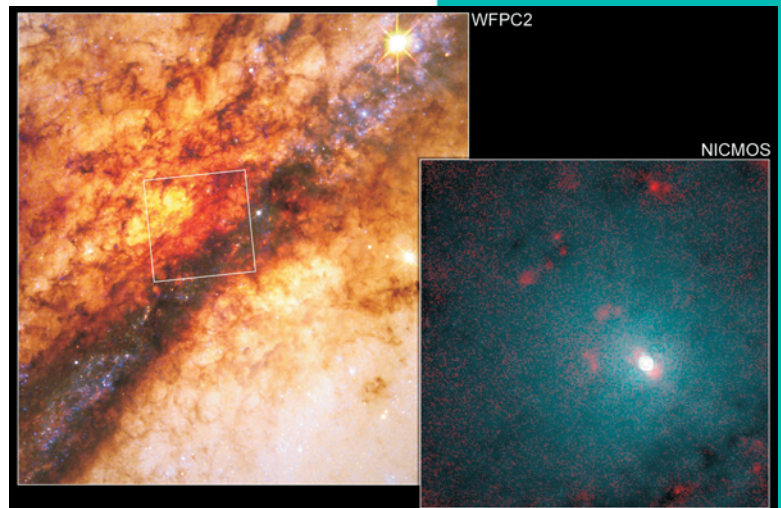

active galactic nuclei



dusty galaxies



supernovae

*'Twould be lonely,  
'twould indeed,  
If the night were  
void of stars.  
—G.O. Pitcovich  
(from If the Night Were  
Void of Stars.)*

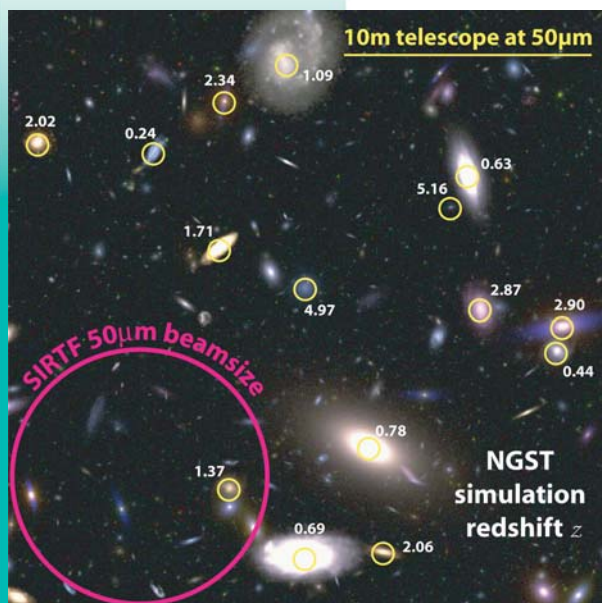

The plan for the SEU theme takes three concerted approaches—cosmic censuses, looking at the Universe long ago and far away, and understanding contemporary mechanisms of galaxy building.

### *Details of a distant youth . . .*

The infrared acuity of a space-based 10-meter far-infrared telescope (small yellow circles) is superimposed on a simulated JWST image of distant extragalactic targets. The large red circle shows that of NASA's SIRTF (a 0.85 m telescope), which is too poor to distinguish individual distant galaxies. The larger telescope will be able to pick out newly born galaxies at the edge of the Universe.

The Big Bang created only the lightest two elements, hydrogen and helium (plus tiny traces of lithium and beryllium). So the first generation of stars formed in warm, dense clouds containing just those two elements. These clouds cooled because hydrogen molecules radiated their heat—at infrared wavelengths that can only be

seen from space. A cryogenic, large aperture infrared telescope would be able to see these molecular lines, and offer a unique window into early star formation. Such a single aperture far-infrared (SAFIR) mission could build upon James Webb Space Telescope (JWST) technology.

The first solid particles, “dust,” condensed from the heavier elements created by the first generations of stars. This was a key event. The dust absorbed light and protected subsequent stellar nurseries from the damaging effects of ultraviolet light. The dust hides these nurseries from optical and ultraviolet instruments but is transparent to the infrared light that the dust emits. For the farthest sources, most of this emission is shifted to wavelengths that are inaccessible from the ground. For this reason, far-infrared and sub-millimeter telescopes in space should find these distant sources to be almost as bright as more nearby sources, making such telescopes powerful cosmological tools.

The carbon, nitrogen, and oxygen created by the first stars radiate in bright emission lines from the infrared through X rays. We can use these spectral lines to measure redshifts and diagnose the radiating gas. The radiation in these lines rapidly cooled the interstellar clouds, leading to even more star formation.

With high spectral resolution these lines can be used to trace the flows of this gas in detail. Most of the line radiation that cools collapsing gas clouds is not accessible to ground-based investments such as the Atacama Large Millimeter Array (ALMA). Cryogenic single-dish space telescopes will provide direct measurements of these lines and, with new large format arrays, be vastly more effective for deep surveys. Submillimeter interferometers in space will eventually offer detailed images, complementing the huge increases in sensitivity that single-dish instruments will provide.

### *The Explosive Enrichment of Galaxies*

The structure and evolution of the Universe is strongly driven by stellar collapse and explosive events, which inject the energy and the elements essential to life into the interstellar gas. To understand the consequences, we need new tools to measure the rates of injection.

Supernovae bright enough to observe directly are relatively rare. But the rapidly expanding remnants they leave behind slowly cool and mix with the surrounding interstellar medium, revealing its composition for centuries afterward. Metals such as gold and

*Visions of new elements from a cosmic furnace . . .*

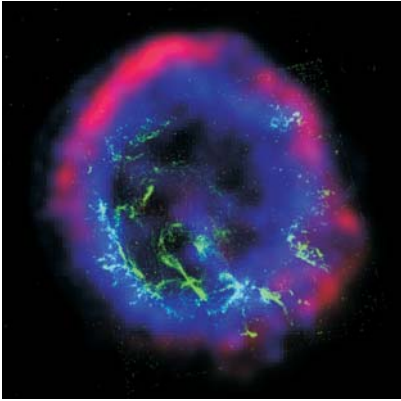

A color composite of the supernova remnant E0102-72: X-ray (blue), optical (green), and radio (red). E0102-72 is the remnant of a star that exploded in a nearby galaxy known as the Small Magellanic Cloud. The Chandra X-ray Observatory image shows, in blue, gas that has been heated to millions of degrees Celsius by the rebounding, or reverse shock wave. The X-ray data show that this gas is rich in oxygen and neon. These elements were created by nuclear reactions inside the star and hurled into space by the supernova.

silver are signatures of the supernova explosion process itself. Most of the material of supernova remnants shines brightly with X-ray lines and Constellation-X will play an important role in determining their makeup: Cosmic rays provide another sample of material from the vicinity of supernova explosions.

Radioactive elements are formed in detonation and core collapse supernovae, during nuclear burning on white dwarf novae, and in the inner accretion disks of neutron stars and black holes. An advanced Compton telescope that can see the radiation from these radioactive decays can be used to study the explosion mechanisms in core-collapse supernovae. While pioneering efforts have come out of the Compton Gamma Ray Observatory, and will be strengthened by ESA's INTEGRAL, a dramatic improvement in sensitivity is required to study more than a few supernovae and to make measurements on a time scale shorter than the decay lifetimes of the key isotopes. Recent technical advances offer increased sensitivity, lower background, and improved energy resolution.

Gamma-ray line telescopes will also help studies of classical novae, in which hydrogen-rich material from a close companion is more delicately deposited on a white dwarf, inducing a localized thermonuclear runaway. Even in these smaller explosions, short-lived isotopes of light elements are produced and should be detectable over much of the galaxy.

Studies of gamma-ray bursts (GRBs) have produced some of the most striking science of the last decade. The Compton Observatory established that GRBs were uniform over the sky. The European Beppo-SAX mission identified optical afterglows that demonstrated that GRBs are extragalactic in origin. As a result, these bursts are now understood to outshine, for minutes at a time, the galaxies in which they originate. Those that last longer than about one second are most likely associated with massive stars and core-collapse supernovae. While the statistics are still sparse, future survey missions such as Swift and GLAST will dramatically enhance the sample.

Some gamma-ray bursts signal the death of a star and the birth of a black hole. Others may arise when a star is swallowed by a nearby black hole. The bursts are so bright that they can be seen even from the distant, early generations of stars. A wide-field, high-sensitivity advanced Compton telescope, and the Black Hole Finder Probe from the *Beyond Einstein* program, will search for dim GRBs, both nearby and distant. Ground-based and space-based optical follow-up studies will supplement these efforts, providing redshifts and identifying the host galaxy.



active galactic nuclei



dusty galaxies



supernovae

*Seeing the earliest stars in the earliest galaxies is now within our technological reach. We will build telescopes that will do this, and efficiently detect and assay interstellar gas out of which these stars are made.*

*Future telescopes will let us see nucleosynthesis happen, and chart how the Universe gets seeded with the materials out of which we are made.*

*Glowing embers of galactic nucleosynthesis . . .*

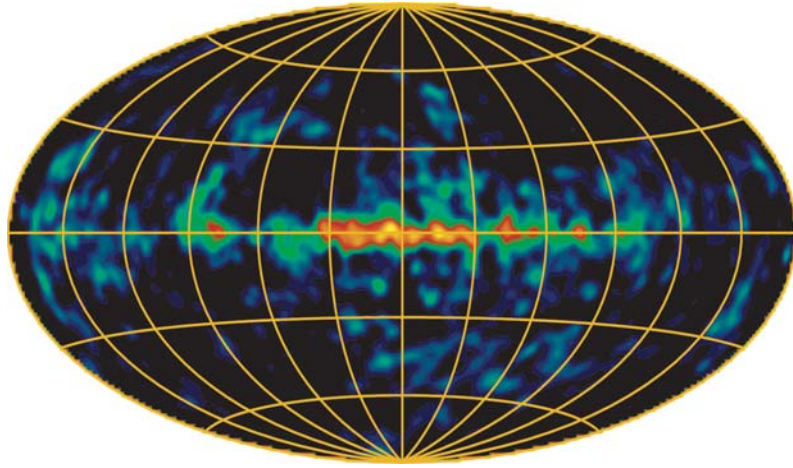

In this wide angle 1.809 MeV gamma-ray view of the Milky Way Galaxy from NASA's Compton Gamma -Ray Observatory, bright spots made by radioactive  $^{26}\text{Al}$  show clearly. With a half-life of about a million years—short compared with the timescale of nucleosynthesis—the bright spots that concentrate in the inner galaxy must be contemporary sites of elemental enrichment.

*Light and Wind from the Heart of the Beasts*

*Beyond Einstein* focuses on the physics of spacetime around compact objects and in the early Universe. Compact objects—white dwarfs, neutron stars, and black holes—are the endpoints of stellar evolution. Their physics determines how energy and matter are deposited throughout the Universe, and they play an important role in its structure and evolution. These objects also allow observational access to extremes of density, pressure, temperature, and magnetic field energy. Neutron stars offer extraordinary densities of matter and magnetic field strengths. Unique processes, including coherent synchrotron emission from pair cascades and the magnetic-field conversion of gamma rays to electron-positron pairs, take place near these objects. These cosmic laboratories test physics under extreme conditions that we cannot reproduce on Earth.

Compact objects can be probed in many ways. A cooling neutron star appears as a hot object in X-rays. Neutron stars

*Revealing gravitational rogues inside galaxies . . .*

The Chandra X-ray Observatory's image of the galaxy NGC 4697 reveals diffuse hot gas dotted with many point-like sources, which are due to black holes and neutron stars in binary star systems. The bright central source is probably due to a supermassive black hole in the nucleus of the galaxy.

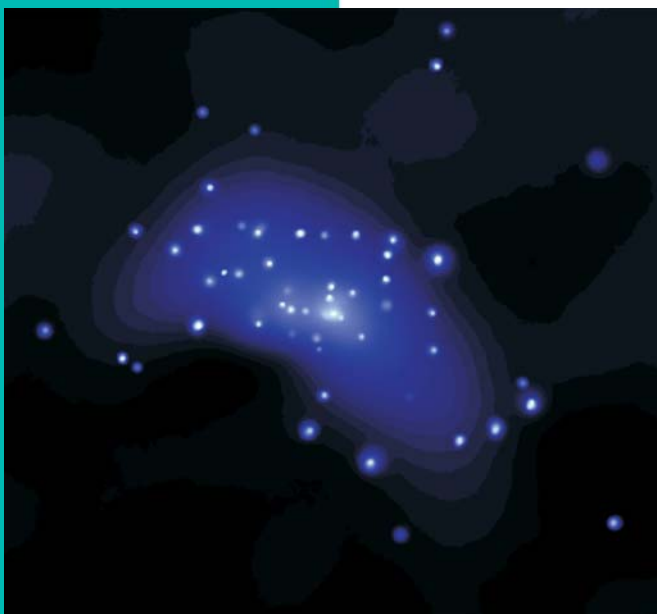

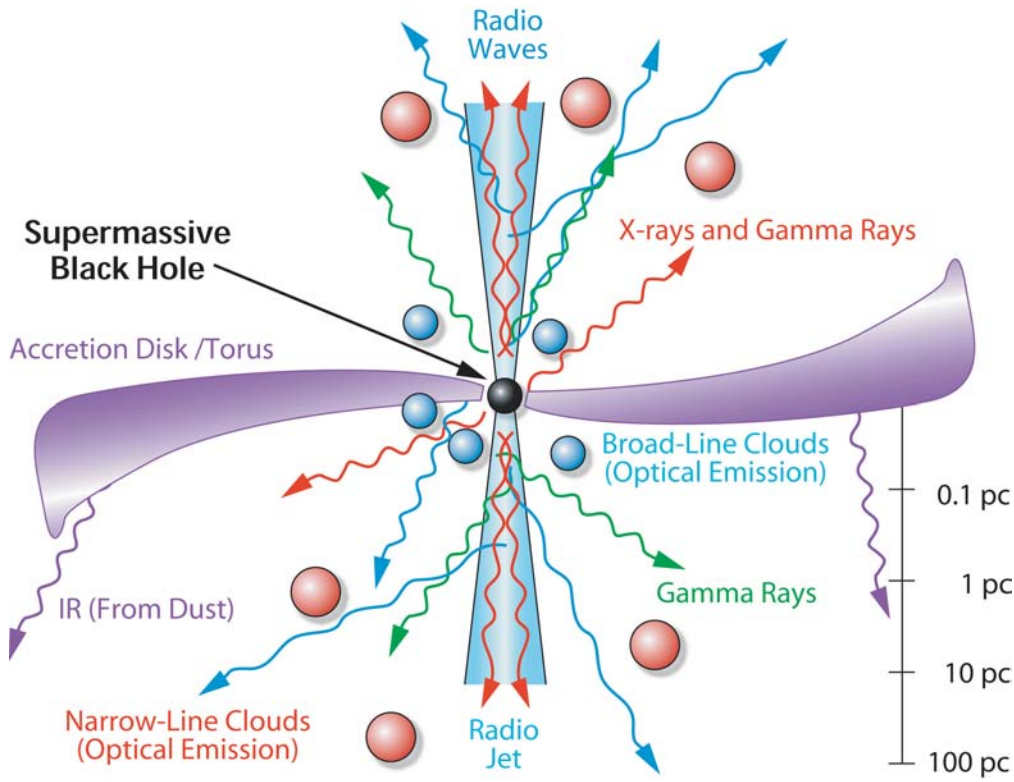
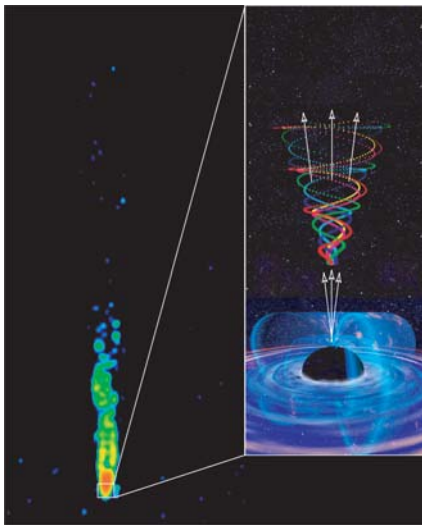

Diagram of AGN with warped disk. Note nonlinear scale; 1 pc = 3.3 light years.

cool over a few thousand years, and their cooling rate and spectra provide information about the neutron star interior. Matter falling onto a neutron star from a binary companion also heats up and can ignite in thermonuclear explosions. Oscillations in the X-ray emission of compact objects reveal instabilities in the accretion disk and even the underlying

*Firing celestial beams of matter . . .*



The large improvement in spatial resolution of space radio interferometry over that from the ground allows the inner parts of nearby galactic accretion disks, and even event horizons of nearby black holes to be probed. At left is a VLA image of the jet flowing out of the supermassive black hole in the galaxy NGC4158. At right, an artist's conception of the launch region of the jet, with the event horizon of the black hole at center. It is this vastly smaller scale that space interferometry will probe.



active galactic nuclei



dusty galaxies



supernovae



Peering into the hearts of galaxies, we will use new telescopes to study the powerful flows of matter and radiation that emanate from the massive black holes at their cores.

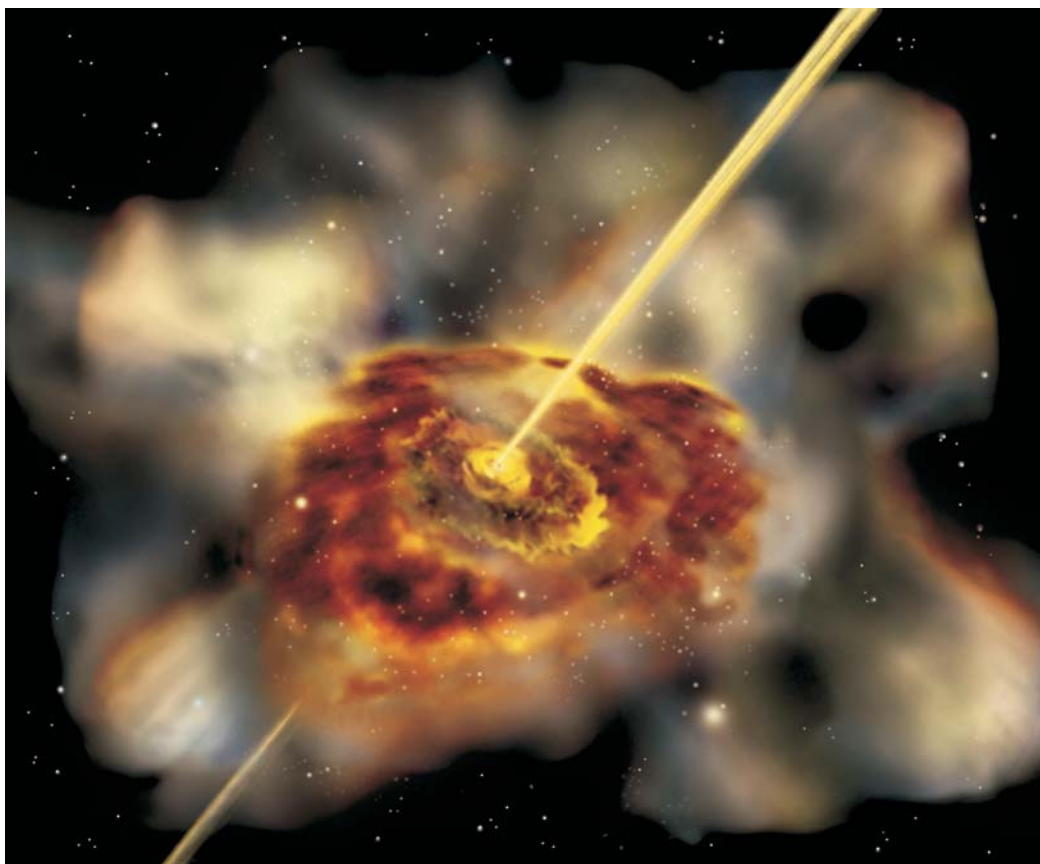

***Swirling disks of death around black holes . . .***

In this artist rendering, gas spirals into an accretion disk around a supermassive black hole at the core of a galaxy. The gravitational energy liberated by the infall causes the central region of the disk to become fiercely luminous and it drives a jet of material outward along the polar axes of the galaxy.

physics of the hidden neutron-star interior. Compact object studies reveal the activity of high-mass stars that produce the heavy elements required for life to form.

In recent years, NASA missions such as the Chandra X-ray Observatory and the Compton Gamma Ray Observatory (CGRO) have shown that gas falls onto compact objects via accretion disks. As the gas falls in, it heats up and emits powerful radiation that can be seen by high-energy telescopes, or indirectly with infrared and radio telescopes.

These nuclear furnaces are often shrouded by the very dust and gas that provides the fuel for the beast. The veil can be penetrated by infrared, radio, and X-ray, or gamma radiation. The Gamma-ray Large Area Space Telescope (GLAST), now in development, will see the most energetic regions around black holes. The Black Hole Finder Probe from *Beyond Einstein* will take a census of nearby black holes. These studies will help us pin down the role black holes have played in the development of galaxies.

Quasars are active galactic nuclei (AGN) so bright that they outshine the surrounding galaxy. The evidence suggests that their radiation is produced by a supermassive black hole ingesting material from the galaxy surrounding it. Because of their high luminosities, AGNs can be seen at very great distances, providing fundamental information about

the era when AGN were far more common and the Universe was only 20 percent of its present age. The James Webb Space Telescope (JWST) and a more powerful successor to HST could be used to study AGN during this epoch.

Did supermassive black holes form by merger of smaller ones, were they massive when they first formed, or did they grow by eating their galaxies from the inside? The Chandra X-ray Observatory has detected supermassive black holes out to  $z = 5$ , long before most stars were formed. LISA and JWST will measure the properties of even more distant black holes. Constellation-X will study these galaxies in spectroscopic detail, determining their composition and the rate at which they are being devoured by their central black holes. Such observations would help us design an eventual vision mission that could see even quiet galaxies at great distances and round out our picture of galaxy formation.

Since the accretion disk is the supplier of fuel for compact objects, better understanding of these objects will require us to figure out how the disks collect matter and funnel it into the central hole. New instruments from the *Beyond Einstein* program will help us study the innermost parts of the accretion disks of supermassive black holes.

Accretion disks are also studied on larger scales using ground-based very long baseline interferometry (VLBI). This can map radio-emitting material in the accretion disk with a resolution over a hundred times finer than HST gets at visible wavelengths. Recent VLBI maps of AGN have detected intense maser emission from water molecules. This emission arises in the cool, outer parts of the accretion disk and has made it possible to measure the masses of several nearby supermassive black holes with unprecedented accuracy.

The full power of radio interferometry will not be realized until space-based telescopes provide longer baselines and shorter wavelengths. Molecular maser lines would offer information about mass motions in the cooler, outermost part of the disk. A radio interferometry mission would resolve accretion disks around AGN out to almost 200 Mpc and probe the inner disk that surrounds the closest supermassive black hole, in the galaxy M87. Such measurements would supplement the more complete dynamical picture provided by Constellation-X and the vision mission Black Hole Imager.

Of special interest is the black hole that sits quietly at the center of our own Milky Way galaxy. As the closest massive black hole, it offers special opportunities. While it now seems to be accreting little matter, a more exciting recent history may be reflected in the motions of nearby material. Though hidden from optical view by the disk of our Galaxy, this material is accessible to us at radio, infrared, and X-ray wavelengths.

Accretion disks around black holes often produce powerful “jets” along their polar axes, which effectively clear away the raw materials of star formation in these directions. Understanding how these jets are made, and what role they play in the accretion process, is a major unsolved problem. While jets have now been observed throughout the electromagnetic spectrum,



active  
galactic  
nuclei



dusty  
galaxies



supernovae

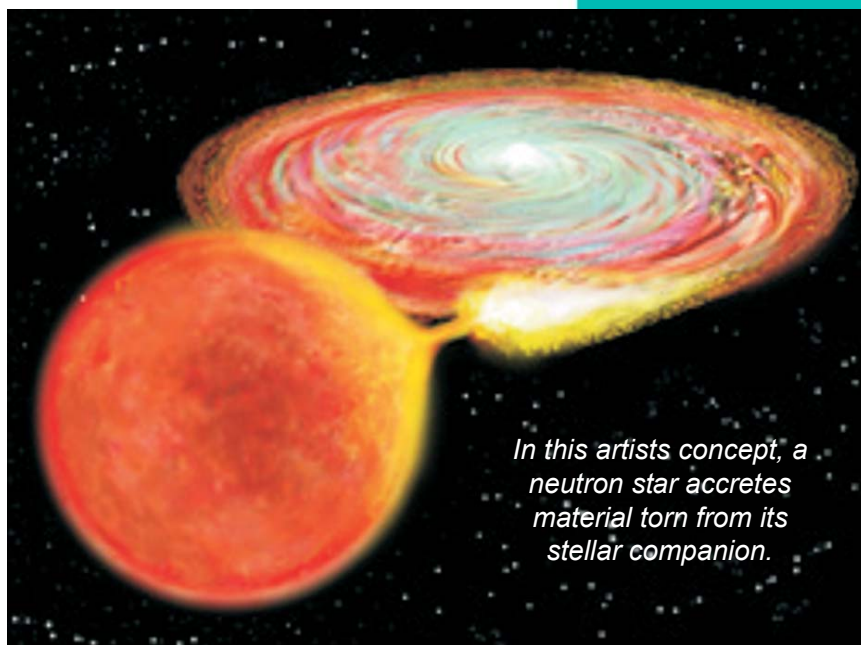

*In this artists concept, a  
neutron star accretes  
material torn from its  
stellar companion.*

*We are ready to understand how the standard candles burn, lighting our way to the early Universe.*

*Antimatter is being produced prodigiously in at least our own Galaxy. We will locate the source and understand how it produces this extraordinary material.*

new telescopes with vastly increased sensitivity, spectral resolution, and clarity of view such as Constellation-X will permit a coordinated attack on gas flows in these disks, and the acceleration mechanisms by which the jets—truly cosmic cannons—are formed.

Detailed comparison of star formation in galaxies with active nuclei will be needed to investigate the roles that accretion disk-driven winds and point-like gravitational fields have on the formation of stars and the evolution of galaxies.

### ***Understanding Nature’s Flash Bulbs to Measure the Universe***

Supernovae play a profoundly important role in the chemical enrichment of the Universe. But they can also help us measure it! Type Ia supernovae are uniquely important in this regard because they are very bright and have roughly constant peak brightness. These cosmic flash bulbs can thus be used to measure the large scale geometry of the Universe. An intensive hunt for such supernovae is under way and early results have led to the monumental realization that the expansion of our Universe is accelerating. While Type Ia supernovae (SN Ia) appear to be ideal for this kind of work, and provide a possible basis for the Dark Energy Probe of the *Beyond Einstein* program, their utility as a standard candle ultimately rests on our detailed understanding of their nature. They most likely arise from the detonation of a white dwarf that pulls so much mass off of a nearby companion that it collapses, triggering an explosive thermonuclear burn. But we cannot understand the evolution of their properties over cosmic times without modeling their nuclear burning and dynamics.

A supernova of Type Ia can eject large quantities of newly formed radioisotopes. These can be identified by their characteristic gamma-ray emission lines. By observing and modeling this radiation, missions such as an advanced Compton telescope and a hard X-ray spectroscopic imager will provide a solid basis for the use of Type Ia supernovae as a probe of cosmology. Such telescopes could detect all Type Ia supernovae out to at least the Virgo Group, providing a sample of many events per year.

### ***Visions of Annihilation***

Our Universe is asymmetric. Most of the elements are made from normal matter (“baryons”). We know that antimatter exists in the Universe, but the amount and distribution remain uncharted. While the search for antimatter can be conducted with cosmic-ray and gamma-ray experiments, our Galaxy, and perhaps our Universe as a whole, is faintly glowing from annihilation of a lightweight form of antimatter, the positron (or antielectron). In such an annihilation, an electron and its positron counterpart most often directly annihilate into two 511 keV photons. Positrons are formed by the decay of radioactive elements, or as products of cosmic-ray interactions. Large scale positron production is theoretically expected from black hole antimatter factories.

Low-resolution positron annihilation maps of the Milky Way made by the Compton Gamma-Ray Observatory reveal recognizable features from the disk and inner bulge of our Galaxy, as well as evidence for emission concentrated at the center. The origin of these positrons is unclear, but radioactivity is a likely source. The maps show that positrons are distributed on a Galaxy-wide scale, but the pattern does not match that of any stellar component. Emission from compact sources could be highly transient, indicating that it may be dominated by a few compact sources, such as the mysteriously quiescent black hole at the center.

We look ahead to building new low-energy gamma-ray telescopes designed specifically to search for annihilation radiation. With vastly higher spatial resolution and sensi-

*Searching for sources of antimatter in a galactic forest . . .*

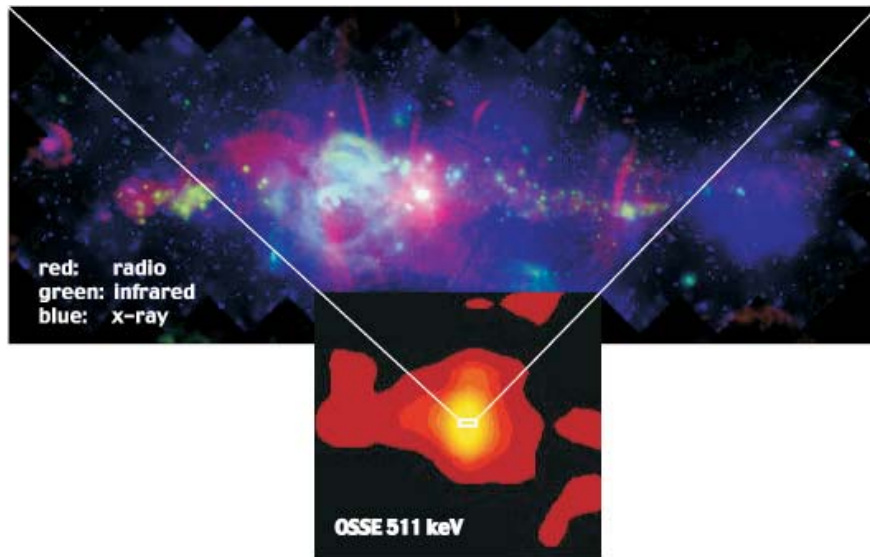

The image of 511 keV radiation from the Compton Gamma Ray Observatory is shown in the lower image and covers about 10 degrees of the sky around our Galactic Center. This is the highest resolution positron annihilation image available. At top is the wealth of structure in the very center of this region as seen in three different parts of the spectrum. This montage illustrates our need for much more detailed images from new generation gamma ray telescopes to identify the sites and sources of antimatter in the inner galaxy.

tivity than the Compton Observatory, such telescopes can reveal discrete sites of positron production in our own Galaxy and measure the production rates in other nearby galaxies. Observing the center of our Galaxy will establish whether a burst of star formation there is responsible for driving a superwind laden with positrons and newly synthesized material.

***The Mystery of the Missing Matter***

According to the best cosmological models, the total mass of the Universe (inferred from its gravitational force) appears to vastly exceed the mass of matter we directly observe. Estimates of the atomic (or “baryonic”) mass of the Universe based on measured primordial ratios of hydrogen, helium, and deuterium can be made. These estimates still exceed the amount that we can actually see in stars and interstellar gas by a factor of ten, suggesting that a large component of normal matter is hidden in some way. But the gravitational mass of the Universe is much larger still, implying that much of the mass of it is not even in the form of atoms or their nuclear constituents. This “non-baryonic” matter would neither emit nor absorb light of any form and would reveal its presence only through gravity. Determining the nature of this non-baryonic dark matter is one of the central goals of modern physics and astronomy.

To keep their stars and hot gas from flying away, we infer that galaxies must be surrounded by halos of non-baryonic dark matter that provide additional gravitational attrac-

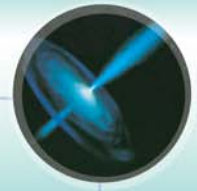

active galactic nuclei



dusty galaxies



supernovae

*New generation telescopes will be able to locate and assay both the baryonic and non-baryonic components of the missing matter, answering a longstanding problem with profound cosmological ramifications.*

tion. Elliptical galaxies contain hot X-ray emitting gas that extends well beyond where we can see stars. By mapping this hot gas, which has been one focus of X-ray missions such as Chandra, XMM-Newton, and soon Astro-E2, we can develop a reliable model of the whole galaxy, showing where the dark matter lurks. Constellation-X will give a dynamical handle on the problem. Gravitational lensing provides yet another probe of dark matter.

The missing baryonic matter is also important and elusive. Although some could be hidden from us in collapsed gas clouds or cold stars too dim to see, most is now believed to lie between the galaxies in the form of very tenuous and nearly invisible clouds of gas. Some may be associated with galaxies themselves, and some may follow the intergalactic web defined by non-baryonic matter. We want to find this missing matter to understand why so little of it was used to build stars and galaxies. By 2010, surveys will have outlined the distribution of luminous baryonic matter in and around galaxies in fine detail, but the intergalactic component will still be largely unexplored.

An efficient way to locate missing baryonic matter in the darkness of intergalactic space is to look for absorption of light from distant quasars. The Lyman  $\alpha$  line is an exquisitely sensitive probe for cold hydrogen gas. If the baryonic dark matter is mainly primordial, such an ultraviolet detection strategy would be the only option. If the gas is hot and chemically enriched, then Constellation-X and large next-generation X-ray and ultraviolet telescopes will be able to see absorption lines from heavier elements. These efforts are difficult and just beginning on HST, FUSE, and Chandra. Constellation-X and new generation ultraviolet and X-ray telescopes will be needed to complete the task.

The fluctuations of the cosmic microwave background radiation are a powerful tool for assessing the total mass content of the Universe. First detected by the COBE a decade ago, these fluctuations have a scale size that will be characterized by the recently launched Microwave Anisotropy Probe (MAP). ESA's future Planck mission will extend this to smaller scales and look for polarization signatures. The most important fluctuations are on scales of arcminutes, so it is essential to map the distribution of dark matter on a comparable scale. The *Beyond Einstein* program includes an Inflation Probe that will measure the polarization of this background. This polarization will reveal gravitational lensing by intervening matter, light or dark.

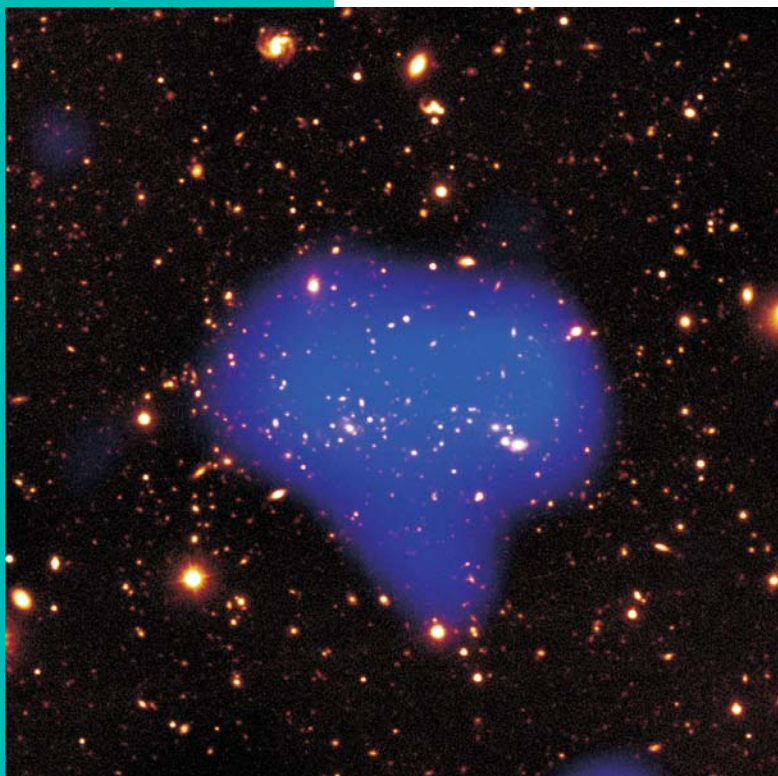

#### *Making missing matter appear . . .*

The NGC 2300 group of galaxies contains a large reservoir of million-degree gas glowing in X rays. A false-color X-ray image of the hot gas (blue cloud) taken by ROSAT is superimposed here on an optical picture of the galaxy group. Gravity from the luminous parts of the galaxies alone is not enough to keep the gas in its place. There must be large quantities of dark matter whose gravity is preventing the gas from escaping.

*Warped images from a clumpy Universe . . .*

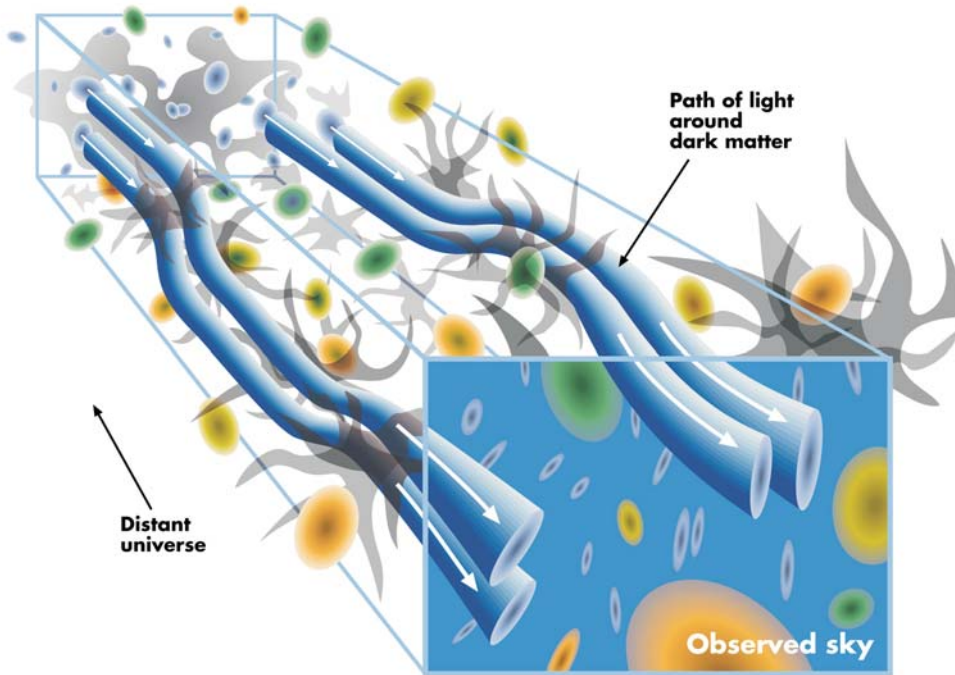

Light rays from distant galaxies travel a tortuous path through a Universe filled with a web of clustering dark matter. Every bend in the path of a bundle of light from a distant galaxy stretches its apparent image. The orientation of the resulting elliptical images of galaxies contains information on the size and mass of the gravitational lenses distributed over the light path.

Once we understand the missing baryonic matter, we will have the first glimpses into the role that it plays in the evolution of our Universe.

***Bullets of the Cosmos***

The origin of cosmic rays is a 90-year-old mystery. Most of these high energy nuclei are thought to be hurled at us by supernova shock fronts, perhaps from collisions with dust grains. Future measurements of the abundances of trace elements in cosmic rays can determine the nature of their sources and the time between the elements' creation and acceleration.

The distribution of cosmic-ray energies is remarkable in that it is almost a constant power law over at least 13 decades in energy. A small steepening, or “knee,” in the power law near  $10^{15}$  eV is thought to represent the limit to energies achievable by supernova shock acceleration. A mission designed to measure the composition of these cosmic rays will explore their connection to supernovae by identifying these high energy nuclei.

At higher energies, the mystery deepens. In fact, we have detected cosmic rays up to about  $10^{20}$  eV, where individual atomic particles have the energy of a well-hit baseball! About the only conceivable sources for these particles are galactic nuclei, giant extragalactic double radio sources, or the mysterious sources that give rise to gamma-ray bursts.

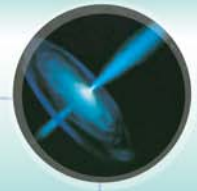

active galactic nuclei



dusty galaxies



supernovae

*Cosmic rays are a window into how nature can channel enormous power into individual atomic nuclei. New observatories will reveal how our Universe is able to act as an extreme particle accelerator, the power of which is unapproachable on Earth.*

Scattering off cosmic background photons should make the Universe fairly opaque to these highest-energy particles, so they must come from nearby sources. It has been suggested that the highest-energy particles could come from the annihilation of topological defects formed in the early Universe. The detection rate of these particles is so low that we see too few to describe their properties well. The DOE/NSF/UNESCO Pierre Auger Observatory now under construction is the next step in understanding these exceedingly rare but energetic particles. Results from it will inform the design of space instruments capable of monitoring still larger areas of the Earth's atmosphere for the showers these rare particles produce, to determine their energy spectrum and source directions.

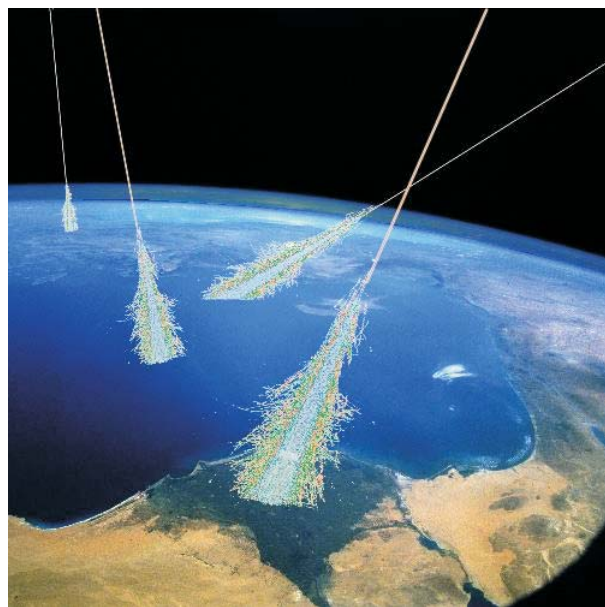

Simulations of particle showers produced by  $10^{20}$  eV cosmic rays in the Earth's atmosphere.



active  
galactic  
nuclei



dusty  
galaxies



supernovae



## ***Chapter 7. Technology Roadmap: Cycles of Matter and Energy***

The SEU science program in the area of Cycles of Matter and Energy will encompass measurements across the entire electromagnetic spectrum, from radio waves gamma rays, as well as measurements of other forms of cosmic radiation: cosmic rays, dark matter, and gravitational waves. Improvements in sensitivity, spectral and spatial resolution, and collecting area are needed. This will require vigorous technology development. In their earliest stages of concept development, new space technologies will be pursued through the R&A programs. NASA's SBIR (Small Business Innovative Research Program) provides another vital yearly addition to SEU technology development. However, technologies developed in both of these programs will eventually require detailed engineering studies. From that point on, future SEU missions cannot succeed without the focused and stable funding of a dedicated technology program.

Highlighted below are the technologies required for SEU missions that are currently envisioned. These encompass optics, detectors, and spacecraft systems.

### **Large, Lightweight Optics**

Continuing exploration of the Universe will require bigger and better space telescopes at all wavelengths. Robust large-aperture lightweight optical systems must be developed if launching is to be feasible and affordable. Ways must be found to increase apertures, reduce density, lower operating temperatures, and improve surface quality, through programs that are rapid and cost effective.

Stiffer materials would permit larger apertures with lower areal densities. Low and uniform coefficients of thermal expansion will simplify cryogenic operation. Stress-free deposition and curing would enable low-cost mass production.

Fabrication poses many challenges, from the logistics of handling large and fragile optical components to the treatments required to obtain the desired surface quality and the development of cryogenically cooled optics. Research must investigate a broad range of techniques for grinding, polishing, and forming. Means for characterizing optical performance and in-space contamination, both by measurement and analysis, are essential. As optics become larger and lighter, adequate ground testing may no longer be feasible. Analytical modeling will be crucial to the success of such missions.

### **Detectors**

Detector technologies in all electromagnetic wavebands have advanced dramatically in recent years, enabling most of the SEU missions currently flying or nearing launch. A detector is characterized by its quantum efficiency, its spectral bandpass, and in some cases its intrinsic spatial and spectral resolution. Ancillary technologies include readout electronics, digital processors, and cooling systems. The demands of upcoming missions will require major advances in all of these areas. NASA support is particularly urgent for detector technologies without strong commercial or military research and development programs. A few examples are detailed below:

#### ***Radio Interferometry***

Space-based (or space-to-ground) radio interferometry requires improved sensitivity, particularly at the shorter wavelengths. High-priority technologies include large space-based

*"Equipped with his five senses, man explores the Universe around him and calls the adventure science."  
—Edwin P Hubble*

## THE ELECTROMAGNETIC SPECTRUM

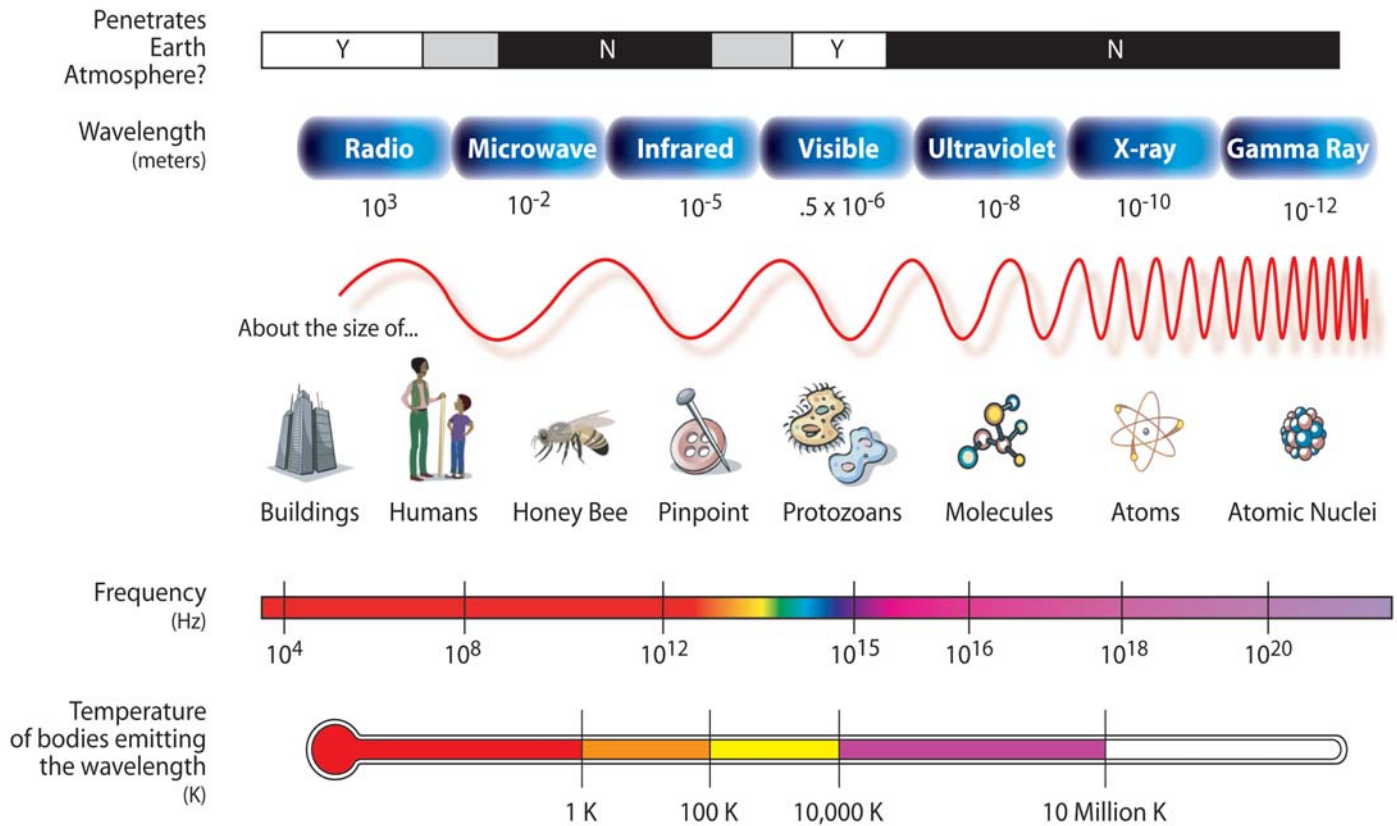

apertures with submillimeter surface accuracy, wide-bandwidth communications from space to ground, and cooling for receivers in space. Since optimum imaging for space-ground baselines requires highly elliptical orbits that pass through Earth's radiation belts, robust materials and electronics for a high-radiation environment are essential. Correlation of high bandwidth signals will also demand precise orbit determination.

### *Submillimeter/Far Infrared*

Cooled space-borne telescopes will permit huge sensitivity gains at these wavelengths, but these will be wasted without large format detector arrays. Direct detectors and heterodyne instruments are needed. The direct detectors need architectures and readout electronics that will scale to large arrays, and greatly improved sensitivity if they are to be used for spectroscopy. Heterodyne systems need more stable oscillators and quieter electronics, especially at the highest frequencies.

### *Near Infrared/Optical*

Imaging detectors based on charge coupled devices (CCDs) and low bandgap array detectors have been available for a number of years. Future missions demand extremely large (billion-pixel) arrays, posing new challenges in production yield, detector uniformity, detector packaging, high-speed readout, and on-board data storage. Improvements in read-

out noise, quantum efficiency, spectral coverage, charge transfer efficiency, and radiation hardness will also be required.

### *Ultraviolet*

Significant improvements in ultraviolet detector sensitivity are needed. Photocathode-based photon counters permit high counting rates and good background rejection but suffer from low quantum efficiency. UV-sensitive CCDs have higher quantum efficiency, but read noise is too high for faint source spectroscopy. So-called 3-D energy-resolving detectors offer tremendous promise, but much larger arrays must be developed.

### *X Ray*

At X-ray energies, cryogenic detectors have revolutionized the field in recent years. Thirty-by-thirty arrays of microcalorimeters are envisioned for Constellation-X, but such small arrays have very limited fields of view. Future missions will need much larger arrays.

### *Gamma Ray*

Gamma-ray astronomy can progress through development of an advanced Compton telescope for the study of nuclear lines and continuum emission at MeV energies. The science goals require 25–100 times the sensitivity of CGRO and INTEGRAL. This will demand major improvements in angular resolution, detector area and field of view, and background rejection. Advances in electronics, detector cooling, and event processing are also required.

### *Cosmic Rays*

Future cosmic-ray research will require large-area million-channel particle detectors. These require low power acquisition electronics, intelligent data compression systems, and fast computing. Space-based observations of cosmic-ray showers via air fluorescence will require fast million-pixel, wide-field light detectors.

## **Spacecraft Systems**

Continued advances in spacecraft technologies are crucial to SEU science goals. Several of the envisioned missions incorporate interferometric systems on multiple spacecraft that need precision pointing and/or formation flying systems. Thermal and mechanical stability tolerances are very tight, so new materials and mechanical designs must be studied. Requirements on the accuracy of positioning and pointing are beyond the state of the art. Advanced inertial reference systems may be required. Micronewton thrusters, currently under development for LISA, require further study for adaptation to other missions.

The sensitivity goals of several envisioned missions require new cryogenic technology, in both active and passive cooling. This is especially true in the submillimeter and far infrared bands, where all the optics must be cooled, including the primary mirror. And we must not forget the hostility of a cryogenic space environment to simple yet critical devices: hinges, latches, and actuators.



## **Part III**

# **Supporting the Roadmap**



## Chapter 8. The Explorer Program

NASA's Explorer program is vital to realizing the SEU theme's objectives. It offers frequent opportunities to carry out small and medium sized missions (SMEX and MIDEX) that can be developed and launched in a short (approximately four-year) timeframe. These focused missions can address science of great importance to the SEU theme and respond quickly to new scientific and technical developments. The Mission of Opportunity option enables valuable collaborations with other agencies, both national and international. Explorer Missions and Missions of Opportunity are selected for science value through competitive peer review.

Explorer missions currently in operation or development that address directly the SEU science objectives include:

The Microwave Anisotropy Probe (MAP), a MIDEX mission launched in 2001, will answer fundamental questions about the age and matter density of the Universe and is a vital precursor to the Inflation Probe of the *Beyond Einstein* program. Prototypes of the advanced spectroscopes for Contellation-X will fly as a Mission of Opportunity on Japan/NASA's Astro-E2 in 2005. Other proposed Explorers are relevant to *Beyond Einstein*, including both missions of opportunity (e.g., laser ranging equipment attached to missions to other planets for precision tests of relativity in the Solar System) and dedicated missions.

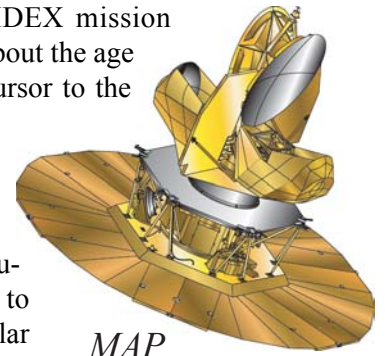

MAP

Several Explorers besides Astro-E2 will address the science objectives of Cycles of Matter and Energy. The Galaxy Evolution Explorer (GALEX), a SMEX mission launching in early 2003, will map the global history and probe the causes of star formation over 80 percent of the life of the Universe. SPIDR, a SMEX mission launching in 2005, will detect the matter that makes up the "cosmic web" on which the structure of the Universe evolved. Swift, a MIDEX mission to be launched in late 2003, is dedicated to the study of gamma-ray bursts.

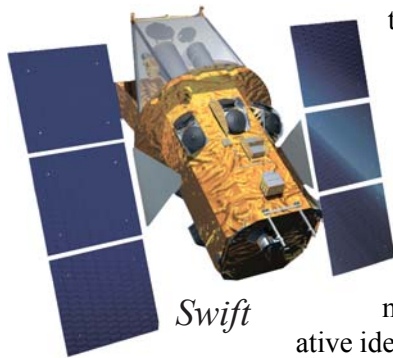

Swift

Each solicitation for Explorer proposals elicits more high-quality experiments than can be implemented. Peer review, the ability to implement new, creative ideas, and quick reaction to recent discoveries are essential elements of the high science value of the Explorer program. Suggesting a queue of future Explorer missions would countermand this mandate.



laser  
interferometer  
space antenna



constellation-x



einstein probes



## Chapter 9. Research and Analysis

The SEU Research and Analysis (R&A) program provides opportunities to develop new ideas, concepts, and methods. These are crucial to the health of the SEU theme and often form the basis for new mission concepts. It has strong university involvement, providing the additional return of training graduate students and instrument builders for future space missions. Veterans of the R&A program become Principal Investigators of flight missions, major instrument builders, or sometimes even astronauts!

There are two major components to R&A: (1) experimental research (including hardware development, suborbital flights, and laboratory astrophysics), which creates new tools, and (2) interpretive research (theory, observations, and data analysis), which makes discoveries and predicts new directions. We consider each in turn.

### Experimental Research: Creating the Tools of Investigation

The R&A experimental program develops novel tools for new and better science. Ideas are tested in laboratory demonstrations and suborbital flights by balloon or rocket. This provides a cost-effective shortcut to mission-readiness for new technology.

#### Hardware Development

The R&A program is the cradle for the technology of SEU's future missions. The R&A hardware program takes development to the proof-of-concept level. At the point where engineering issues dominate, the SEU's Technology Line takes over. Mission-specific funding carries development to completion. This three-stage approach is cost-effective, encourages innovation, and minimizes risk.

The candidate detectors for Constellation-X were all born in the R&A program. These detectors have flown on ASCA and the Chandra X-ray Observatory and are slated to fly on Astro-E2 and Swift. The R&A program also developed the specialized bolometers that will fly on Herschel, Planck, and several suborbital missions. The COBE and MAP detectors are the fruits of previous R&A development.

*“Progress in science depends on new techniques, new discoveries and new ideas, probably in that order.”*

*—Sidney Brenner  
[Nobel Prize, 2002]*



Future missions will need innovative optics. High-resolution segmented optics, such as those used on ASCA, were first developed within the R&A program. Multilayer coatings for hard X-ray optics are currently under development. Nanotechnology developed in the R&A program enabled high-resolution spectroscopy for the Chandra observatory and will enhance high-resolution imaging optics, technologies critical for Constellation-X and an X-ray Black Hole Imager.

### ***Suborbital Program***

The Suborbital Program produces exciting scientific results while also serving as a testbed for hardware and a training ground for future instrument and mission scientists. The BOOMERanG and MAXIMA balloon payloads provided the best power spectra for the CMB anisotropies prior to the advent of MAP. Combined with measurements of large scale structure, they revealed a Universe that is about 70 percent dark energy, one of the most exciting new results in cosmology.

The program features quick turnaround and low launch cost, essential for space-qualifying otherwise risky forefront technologies. Balloon and rocket flights test new capabilities vital to mission development. GLAST, FUSE, Chandra, XMM, Astro-E2, COBE, MAP, Herschel, and Planck have benefited from such efforts. For Constellation-X, balloon experiments carry CdZnTe detectors and hard X-ray optics, and X-Ray microcalorimeters were first demonstrated on rocket payloads. Future suborbital testing will include lightweight and deployable optics, cryocoolers, and detectors.

Suborbital investigations have short lead-times and are ideal for quick response to new discoveries. For example, balloon flights with gamma-ray detectors developed under the Research and Analysis budget made time-critical observations of supernova 1987A.

The suborbital program will soon support Ultra-Long Duration Balloons, which can economically carry payloads of several thousand pounds for long periods to a near-space environment. These balloons can fly at any latitude and have active trajectory control and advanced recovery systems. The potential of this program has been widely recognized and explicitly recommended by the NAS AASC decadal report.

### ***Laboratory Astrophysics***

Combining laboratory experiments, modeling, and theoretical calculations, the Laboratory Astrophysics program provides scientists with the fundamental knowledge and reference data they need to link raw observation and meaningful, scientific conclusions. The program explores a tremendous breadth of topics, from the very coldest regions deep in dark molecular clouds to the extraordinary heat around supermassive black holes. It supports NASA's space missions from conception to completion, defining mission parameters and supporting post flight analysis.

Laboratory Astrophysics includes work on atomic and molecular properties needed to interpret astrophysical spectra. NASA programs and missions require critically compiled stable databases of these properties, available online. The highest priorities for the Laboratory Astrophysics program have been identified in the *Summary of Laboratory Astrophysics Needs* white paper from the 2002 Laboratory Astrophysics Workshop.

The Chandra X-ray Observatory and XMM-Newton have demonstrated the power of high resolution spectroscopy in X ray astronomy, and missions such as Astro-E2 and Constellation-X will build on this foundation. The level of detail now in grating spectra has uncovered discrepancies between observed cosmic X-ray line emission, laboratory measurements, and theoretical calculations. Current models of weak or blended features, such as the complex iron-line region, are often inadequate for interpreting observed cosmic



laser  
interferometer  
space antenna



constellation-x



einstein probes

*“Those who dream by day are cognizant of many things which escape those who dream only by night.”  
—Edgar Allen Poe*

X-ray emission. To unleash their diagnostic power, these discrepancies must be resolved—through sound laboratory and theoretical studies. Laboratory measurements are essential to interpretation of observations at other wavelengths, too. The rich infrared-submillimeter band requires laboratory measurements of the formation of solid grains and ices, and precise wavelengths for diagnostic spectral lines.

### **Theory, Observations, and Data Analysis: Reaping the Benefits of Investment**

Space-based experiments must be firmly rooted in ground-based observation and theoretical calculation. Only then can data analysis close the loop that allows NASA to realize the goals of the SEU program.

#### ***Theory***

Theoretical studies establish the framework within which scientific questions are asked. They allow scientists to interpret data and make the predictions that drive mission design.

Predictions of the spectrum and anisotropy of the Cosmic Background Radiation motivated COBE, MAP, and Planck. The requirements for JWST have been guided by cosmological and stellar evolution theory, and those for GLAST by the theory of particle acceleration and photon interactions in relativistic sources and the Universe. Theoretical work showed that high time resolution X-ray monitoring could probe the strong gravity around black holes and neutron stars, motivating RXTE. Theorists have shown how the X-ray emission lines in accreting black holes can provide unique tests of the general theory of relativity, motivating, and shaping Constellation-X.

Present and planned missions are the fruits of bold theoretical investment in the 1980s and 1990s. Today’s theoretical ideas are bolder still. The R&A program is NASA’s place to nurture these visions and ensure a vital future.

#### ***Ground-based Observations***

Ground-based observations contribute to the development of techniques and instruments in support of space missions.

In addition, great scientific return often comes from the combination of observations across the electromagnetic spectrum. Some of these are most efficiently performed from the ground. Ground-based optical studies of the afterglows of gamma-ray bursts reveal the distance to and the nature of these sources. Nonthermal emission from active galactic nuclei covers the entire spectrum from radio to gamma-ray. Ground-level observations of the atmospheric Cherenkov radiation from gamma rays of the highest energies will complement observations from GLAST. Emissions in various wavelengths from the vicinity of massive black holes correlate on a time scale of days, demanding contemporaneous observation. Ground-based observations will support gamma-ray burst studies by Swift, AGN observations by GLAST, black hole studies by LISA and the Black Hole Finder Probe, and LISA’s white dwarf studies. The Dark Energy Probe will make use of spectroscopy by larger telescopes on the ground.

Ground-based observations should be coordinated with the National Science Foundation to ensure that the highest priority research is conducted most cost-effectively.

#### **Archival Research**

As data from previous and ongoing NASA missions mounts, so too does the value of archival research. Data mined from NASA’s archives have led to a better understanding of

important and interesting astrophysical phenomena. These archives are growing rapidly in both content and diversity. More sophisticated software tools would support searches spanning multiple archives, facilitating valuable scientific investigations long after an observatory has ceased operation. The proposed National Virtual Observatory, to be developed jointly by NASA and NSF, would provide this capability.



laser  
interferometer  
space antenna



constellation-x



einstein probes

## Chapter 10. External Factors

This Roadmap incorporates the highest scientific priorities of the nation, as described in recent studies by the National Academy of Sciences. These include *Astronomy and Astrophysics in the New Millennium* (Astronomy and Astrophysics Survey Committee, C. F. McKee and J. H. Taylor, co-chairs, 2001) and *Connecting Quarks with the Cosmos: Eleven Science Questions for the New Century* (Committee on the Physics of the Universe, M. S. Turner, chair, 2002).

To uncover the fundamental laws of the Universe, we must draw upon the talents and resources of the entire research and engineering communities. We must seek partnerships that make the best use of scarce resources. Success will require a new mode of collaboration across nations, agencies, academia, and industry.

Traditional disciplinary boundaries must be broken down in order to share information and build models that are broader in scope. *Beyond Einstein* brings NASA to the frontiers of fundamental physics. Many missions will involve experimental and theoretical physicists traditionally supported by other federal agencies.

Partner agencies will include the Department of Energy and the National Science Foundation. The collective knowledge of our universities will be tapped to develop the missions and use them to make discoveries. NASA will serve as the lead on some of the more complex missions and as the facilitator in other missions, relying upon academic, industrial, and international partnerships. Collaborations with international partners will be sought to maximize the use of existing capabilities, thereby minimizing duplication of effort, and to reap the benefits of a competition which leads to the incorporation of the best minds and the best technology from around the world. An example where collaboration is already proceeding is the LISA mission which is a 50/50 split between NASA and the European Space Agency. As an example of interagency cooperation, the Department of Energy is funding technology development for one promising approach to a Dark Energy Probe.

Partnerships and collaborations with foreign countries are increasingly affected by the ever more stringent standards of the International Traffic in Arms Regulations (ITAR). To continue to benefit from international partnerships, we must come to grips with a world that feels ever less secure. This will require more front-end planning and cooperation with the agencies charged with protecting our national interests to keep our missions within cost and schedule constraints.

New knowledge must be shared quickly with the general public. As part of NASA's education initiative, we will seek alliances with the education and communications communities.

Technology is often the factor that limits the pace of progress. A shortfall in technology investment would threaten the development of future missions and increase the risk of technical or programmatic failure.

Investments in the infrastructure that enable researchers to communicate, organize, and share information are crucial to ensure the widest participation in the research effort. These assets include the Deep Space Network, supporting orbital and ground networks, data archival and distribution networks, and high-speed ground links.

It is anticipated that the volume of scientific data in future missions will far exceed existing storage capabilities. This may be accommodated in part by distributed data sets. However, the software tools as well as the connectivity for such distributed systems will require new approaches and architectures for synthesizing these data streams. Continual investment in information technology tools will be required to address the spatial, tempo-

ral, and spectral data needed to understand the cosmos. Furthermore, information technology investments to support the on-board control strategies of more capable spacecraft will be essential as we move to an era of constellation or formation flying.

NASA must find new ways to collaborate with industry in the development of critical technologies. Where shared investment makes sense, we need to create mechanisms helpful to such initiatives. A new paradigm is required that allows the government to continue to invest in high-risk areas while planting seeds for “almost ready” technologies that have both government and commercial applications.

The availability of small launch vehicles to place spacecraft into orbit is a growing concern. Cost efficient access to space is required for small payloads and all forms of launch access, both foreign and domestic, must be considered in the future. Concurrently, long-term planning and integration with other launch customers may be needed to pair science missions with like orbital requirements to maximize the use of the remaining expendable launch fleet. The balloon program may also help this situation through refinements of the Ultra-Long Duration Balloon capability to provide up to 100 days of continuous observation time.

Regardless of the orbital strategy chosen, there will be a continuing need for sub-orbital programs of sounding rockets and balloons to perform experiments and test new technologies and instrumentation. Balloon flights from Antarctic bases are especially productive and depend on continued infrastructure and logistics support from the National Science Foundation.

## *Last Word*

This Roadmap for NASA's Structure and Evolution of the Universe (SEU) theme has identified and prioritized the science objectives in space astrophysics:

1. Find out what powered the Big Bang;
2. Observe how black holes manipulate space, time, and matter;
3. Identify the mysterious dark energy pulling the Universe apart;
4. Explore the cycles of matter and energy in the evolving Universe; and
5. Understand the development of structure in the Universe.

The prioritized Roadmap is in good accord with the recommendations of the National Academy of Sciences, including the *Astronomy and Astrophysics in the New Millennium* and *Connecting Quarks with the Cosmos* reports. Guided by the concerted efforts of the space astrophysics community, this Roadmap puts forward a single integrated program of five missions, technology, research, and education to address the highest priority objectives. This is the *Beyond Einstein* program.

Einstein sought, but never achieved, an understanding of how nature works at its deepest level. With *Beyond Einstein*, we seek that next level of understanding. Over the next decade, the *Beyond Einstein* missions will answer fundamental questions about the origin of the Universe and the nature of space and time. In the far future the "vision missions" of this Roadmap will extend our minds even closer to the edges of space and time. These missions will follow matter to the very brink of black holes and detect "particles of time" left over from the beginning of the Universe. We will see beyond the vision of Einstein to the uttermost extremities of existence.

*"The future belongs to  
those who believe  
in the beauty of  
their dreams"*  
—Eleanor Roosevelt

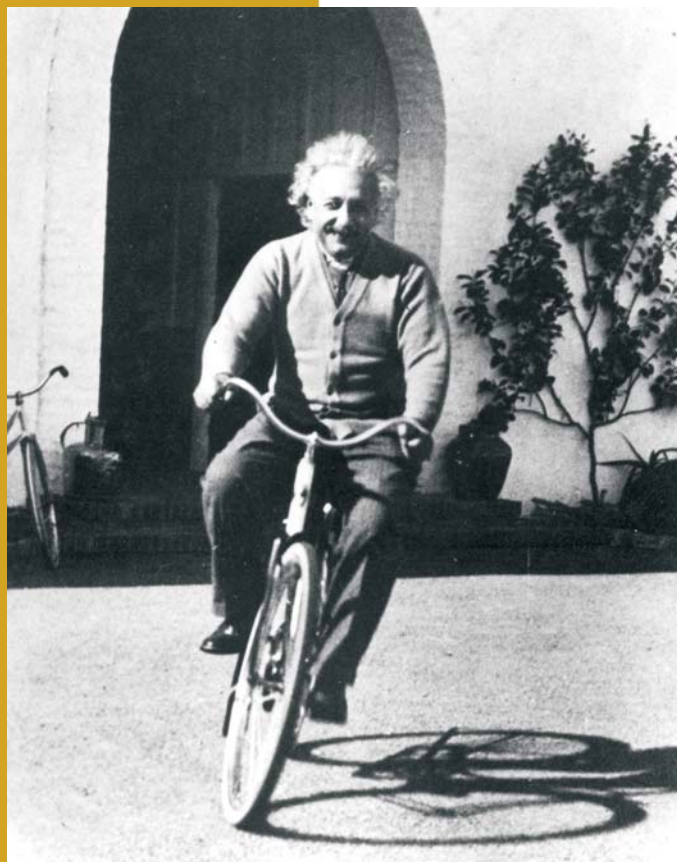





## ***Appendix A. Mapping of Science Objectives and Research Focus Areas to Investigations***

### ***Science Objective 1: Find out what powered the Big Bang.***

*Research Focus Area 1. Search for gravitational waves from inflation and phase transitions in the Big Bang.*

- Search for gravitational wave emission from the early Universe
- Detect the signature of gravitational waves from the Big Bang
- Directly detect gravitational waves from the Big Bang

*Research Focus Area 2. Determine the size, shape, and energy content of the Universe.*

- Measure gravitational wave energy content of the Universe
- Measure the matter and energy content and the shape of the Universe
- Measure the geometry of the Universe using merging black holes as self-calibrated candles
- Map the polarization of the cosmic microwave background and determine sources of this polarization of both large and small scales
- Accurately determine the amount of dark energy in the Universe
- Directly determine the expansion history of the Universe by timing binaries throughout the Universe
- Measure the amount of quantum fluctuation and graviton fluctuation during inflation

### ***Science Objective 2: Observe how black holes manipulate space, time, and matter.***

*Research Focus Area 3. Perform a census of black holes throughout the Universe.*

- Perform an imaging census of accreting black holes, including hidden black holes, in the local Universe
- Determine the masses and spins of accreting massive black holes through observation of broadened emission line from matter near the black hole
- Determine the masses and spins of supermassive black holes through measurement of their gravitational waves
- Observe gravitational radiation from all merging neutron stars and stellar-mass black holes

*Research Focus Area 4. Determine how black holes are formed and how they evolve.*

- Observe gravitational waves from merging black holes
- Investigate how matter releases energy close the event horizon
- Perform population studies of the life cycle of black holes
- Trace the evolution of supermassive black holes in active galaxies
- Study the role of massive black holes in galaxy evolution through the detection of black hole mergers
- Observe gravitational waves from the formation of black holes

*Research Focus Area 5. Test Einstein's theory of gravity and map spacetime near the event horizons of black holes and throughout the Universe.*

- Observe the gravitational redshift of line emission from gas as it enters a black hole
- Determine the spacetime geometry down to the event horizon by detecting gravitational radiation from compact stars spiraling into supermassive black holes
- Test Einstein's theory of relativity under extreme conditions, such as merging supermassive black holes
- Observe gravitational radiation from the formation of black holes and other singularities
- Map the motions of gas near the event horizons of black holes

*Research Focus Area 6. Observe stars and gas plunging into black holes.*

- Dynamically observe the behavior of gas as it enters a black hole
- Investigate how matter releases energy close the event horizon
- Observe compact stars spiraling into supermassive black holes through their gravitational radiation
- Discover ordinary stars being torn apart as they approach black holes
- Observe the gravitational radiation from stars plunging into black holes throughout the Universe
- Map the motions of gas as it enters a black hole
- Map the release of energy in black hole accretion disks
- Determine how relativistic jets are produced and the role of black hole spin in this process

***Science Objective 3: Identify the mysterious dark energy pulling the Universe apart.***

*Research Focus Area 2. Determine the size, shape, and energy content of the Universe.*

- Measure the matter and energy content and the shape of the Universe
- Accurately determine the amount of dark energy in the Universe

*Research Focus Area 7. Determine the cosmic evolution of the dark energy pulling the Universe apart.*

- Measure the equation of state of dark energy
- Measure the cosmic evolution of dark energy
- Accurately determine the amount of dark energy in the Universe
- Directly determine the expansion history of the Universe by timing binaries throughout the Universe

***Science Objective 4: Explore the cycles of matter and energy in the evolving Universe.***

*Research Focus Area 8. Determine how, where, and when the chemical elements were made.*

- Observe the formation of the first generation of stars
- Determine the explosion mechanisms in supernovae where the heavy elements are created

*Research Focus Area 9. Understand how matter, energy, and magnetic fields are exchanged between stars and the gas and dust between stars.*

- Observe the formation of the first generation of stars
- Observe the evolution of the heavy elements through the history of the Universe
- Determine the role of black holes in the formation of galaxies
- Measure the nuclear burning and dynamics of supernovae

*Research Focus Area 10. Discover how gas flows in disks and how cosmic jets are formed.*

- Observe the emission from accretion disks around compact objects in all relevant bands of the electromagnetic spectrum
- Observe the motions of material flowing around the black hole at the center of the Milky Way galaxy
- Determine the physical processes giving rise to the formation of cosmic jets

*Research Focus Area 11. Identify the sources of gamma-ray bursts and cosmic rays.*

- Enhance our understanding of the physical processes that give rise to gamma-ray bursts
- Identify the high-energy cosmic rays
- Determine the amount and origin of the highest-energy cosmic rays

***Science Objective 5: Understand the development of structure in the Universe.***

*Research Focus Area 12. Discover how the interplay of baryons, dark matter, and gravity shapes galaxies and systems of galaxies.*

- Observe the formation of the first generation of stars and galaxies
- Observe the formation of the first heavy elements in supernovae in the early Universe
- Determine the role of black holes in the formation of galaxies
- Determine the role of dark matter in the formation of galaxies

*Research Focus Area 13. Explore the behavior of matter in extreme astrophysical environments.*

- Observe extremes of density, pressure, temperature, and field energy in compact objects
- Determine the physical processes giving rise to the formation of cosmic jets
- Measure the nuclear burning and dynamics of supernovae
- Map sources of annihilation radiation in the Milky Way galaxy and nearby galaxies

*Research Focus Area 2. Determine the size, shape, and energy content of the Universe.*

- Observe the formation of the first generation of stars and galaxies
- Map the dark matter in the Universe
- Detect the absorption of light from distant quasars by dark matter

*Research Focus Area 4. Determine how black holes are formed and how they evolve.*

- Enhance our understanding of the physical processes that give rise to gamma ray bursts
- Observe the emission from accretion disks around compact objects in all relevant bands of the electromagnetic spectrum
- Determine the role of black holes in the formation of galaxies

## *Appendix B. Acronyms*

<b>AASC</b> .....	Astronomy and Astrophysics Survey Committee of the National Academy of Sciences
<b>AGN</b> .....	Active Galactic Nuclei
<b>ALMA</b> .....	Atacama Large Millimeter Array (NSF/Europe, planned)
<b>ASCA</b> .....	Advanced Satellite for Cosmology and Astrophysics, Japan/NASA (defunct)
<b>Astro-E2</b> .....	An X-ray and gamma-ray satellite jointly developed by the US and Japan (planned)
<b>BE</b> .....	Beyond Einstein
<b>Beppo-SAX</b> .....	Satellite per Astronomia, Italy/Netherlands (operating)
<b>BOOMERanG</b> .....	Balloon Observations Of Millimetric Extragalactic Radiation and Geophysics (defunct & 2003)
<b>CCD</b> .....	Charge Coupled Device. A solid state detector of electromagnetic radiation, pioneered in the 1970s for military and astronomical use now also found in consumer digital cameras.
<b>CGRO</b> .....	Compton Gamma-ray Observatory (defunct)
<b>Chandra</b> .....	Chandra X-ray Observatory (operating)
<b>CMB</b> .....	Cosmic Microwave Background
<b>COBE</b> .....	Cosmic Background Explorer (defunct)
<b>Con-X</b> .....	Constellation X-ray Mission (planned)
<b>CPU</b> .....	Committee on the Physics of the Universe of the NAS
<b>DOE</b> .....	Department of Energy
<b>EGRET</b> .....	Energetic Gamma Ray Experiment Telescope on CGRO.
<b>ESA</b> .....	European Space Agency
<b>FUSE</b> .....	Far Ultraviolet Spectroscopic Explorer (operating)
<b>GALEX</b> .....	Galaxy Evolution Explorer (2003)
<b>GLAST</b> .....	Gamma Ray Large Area Telescope
<b>GPB</b> .....	Gravity Probe B (2003)
<b>GRACE</b> .....	Gravity Recovery and Climate Experiment, NASA/Germany (operating)
<b>GRB</b> .....	Gamma-ray burst.
<b>Herschel</b> .....	ESA/NASA far infrared mission (planned)
<b>HST</b> .....	Hubble Space Telescope (operating)
<b>INTEGRAL</b> .....	International Gamma-Ray Astrophysics Laboratory, ESA/Russia/NASA (operating)
<b>JWST</b> .....	James Webb Space Telescope (formerly Next Generation Space Telescope - NGST, planned)
<b>LIGO</b> .....	Laser Interferometer Gravitational-wave Observatory, NSF (operating)
<b>LISA</b> .....	Laser Interferometer Space Antenna (planned)
<b>MAP</b> .....	Microwave Anisotropy Probe (operating)

<b>MIDEX</b> .....	Medium-class Explorers. The most expensive class of NASA Explorer mission.
<b>NAS</b> .....	National Academy of Sciences
<b>NASA</b> .....	National Aeronautics and Space Administration
<b>NGC</b> .....	J.L.E. Dreyer's 1887 New General Catalog (of nebulae and bright galaxies)
<b>NICMOS</b> .....	Near Infrared Camera and Multi-Object Spectrometer on the Hubble Space Telescope
<b>NSF</b> .....	National Science Foundation
<b>OSS</b> .....	Office of Space Science (NASA)
<b>PI</b> .....	Principal Investigator
<b>Planck</b> .....	ESA/NASA cosmic microwave background mission (planned)
<b>ROSAT</b> .....	Röntgen (X-ray) Satellite, Germany (defunct)
<b>RXTE</b> .....	Rossi X-ray Timing Experiment (operating)
<b>SEU</b> .....	Structure and Evolution of the Universe (OSS Theme)
<b>SIRTF</b> .....	Space Infra-red Telescope Facility (2003)
<b>SMEX</b> .....	Small Explorers. The less expensive class of NASA Explorer mission.
<b>SNAP</b> .....	Supernova/Acceleration Probe, DOE (planned)
<b>SOFIA</b> .....	Stratospheric Observatory for Infra-red Astronomy, NASA/Germany (planned)
<b>SMART-2</b> .....	ESA Small Mission for Advanced Research in Technology 2: LISA Test Package (planned)
<b>SPIDR</b> .....	Spectrometry and Photometry of the Intergalactic mediums' Diffuse Radiation (planned)
<b>ST7</b> .....	Space Technology 7. NASA Disturbance Reduction System technology project. (planned)
<b>Swift</b> .....	A multi-wavelength gamma-ray observatory (2003)
<b>ULDB</b> .....	Ultra-Long Duration Balloons
<b>VLBI</b> .....	Very Long Baseline (radio) Interferometry
<b>XMM</b> .....	X-ray Multi-mirror Mission, ESA/NASA (operating)

## Appendix C. Glossary of Terms

"I [attend school] in Nacogdoches, Texas. I feel that more astronomy-based learning should take place- in history and English classrooms as well as science. The heavens are very important to many cultures and I feel our studies in school do not show a true picture of these cultures without a focus on astronomy."  
—Bethany G., Texas

**Accretion.** Accumulation of dust and gas onto larger bodies such as stars, planets, and moons.

**Accretion Disk.** A relatively flat sheet of dust and gas surrounding a newborn star, a black hole, or any massive object growing in size by attracting material.

**Active Galactic Nuclei (AGN).** A core region in certain galaxies that, like a powerful engine, spews large amounts of energy from its center.

**Baryon.** Any subatomic particle of half-integral spin that interacts via the strong nuclear force. (Most commonly, these are protons and neutrons.) The term "hadron" includes the lighter integer spin mesons as well the half-integral spin baryons.

**Big Bang.** A theory of cosmology in which the expansion of the Universe is presumed to have begun with a primeval explosion.

**Big Bang Observer.** A *Beyond Einstein* gravitational wave detector vision mission.

**Brane.** An object or subspace in string theory that can have various spatial dimensions. A 1-brane is a string; a 2-brane is a surface or membrane; a p-brane has lengths in p dimensions.

**Brane World.** A four-dimensional surface (brane) in a higher-dimensional spacetime.

**Black Hole.** An object whose gravity is so strong that not even light can escape from it.

**Black Hole Imager.** A *Beyond Einstein* X-ray interferometer vision mission.

**Coded aperture mask.** A plate with both opaque and transparent elements placed in front of a position-sensitive gamma-ray detector. Sources at different places in the sky cast shadows of the grid at different positions on the detector, allowing an image of the entire sky to be reconstructed, with an angular resolution set by the size of the mask elements.

**Cosmic Background Radiation.** Radiation of the cosmos left over from the Big Bang.

**Cosmological Constant.** A term Einstein added to his equations of the general theory of relativity, to account for an apparently non-expanding Universe, but later rejected when Hubble's observations seemed to indicate it was not needed. Can be interpreted as a special form of Dark Energy.

**Cosmology.** The astrophysical study of the history, structure, and dynamics of the universe.

**Dark Energy.** The residual energy in empty space which is causing the expansion of the Universe to accelerate. Einstein's Cosmological Constant was a special form of dark energy.

**Dark Matter.** Mass whose existence is deduced from the analysis of galaxy rotation curves and other indirect evidence but which has so far escaped direct detection.

**Doppler Effect.** An observer receives sound and light from bodies moving away from her with lower frequency and longer wavelength than emitted (see Redshift) and from bodies moving toward her with higher frequency and shorter wavelength. The shift in frequency increases as the speed of the body increases.

**eV.** Electron Volt. The energy an electron has after being accelerated by a 1 volt potential. Quanta of visible light (photons) have energies of a few eV.

**Event Horizon.** The boundary of the region around a black hole from which nothing can escape once crossed.

**General relativity.** The theory of gravitation developed by Albert Einstein incorporating and extending the theory of special relativity and introducing the principle that gravitational and inertial forces are equivalent.

**Graviton.** The quantum particle, associated with gravitational waves, which carries the gravitational force.

**Inflation.** Postulated period in the very early Universe of extremely rapid expansion, inflating what is now the observable Universe from an atomic size to its cosmological size in a fraction of a second. This process makes the Universe very smooth and flat, as observed.

**Interferometry.** The use of interference phenomena of light waves to measure distances and angles between objects.

**Jets.** Beams of energetic particles, usually coming from an active galactic nucleus or a pulsar.

**keV.** kilo electron Volt. A unit of energy equal to one thousand **eV**. X-ray photons have energies of 0.1-100 keV.

**L2.** The second of five Lagrange points, regions of stable orbit, approximately 1.5 million kilometers from Earth.

**Light Year.** The distance light travels in a year (5.55 quadrillion miles).

**MeV.** Mega electron Volt. A unit of energy equal to one million **eV**. Gamma-ray photons are those with energies greater than 0.1 MeV, equal to 100 keV.

**Neutron Star.** The imploded core of a massive star remaining after a supernova explosion. Contains about the mass of the Sun in less than a trillionth of the Sun's volume.

**Parsec.** The distance to an object that has a parallax of one arcsecond (equivalent to 3.26 light years).

**Planck.** An ESA mission to measure the cosmic microwave background, with NASA participation.

**Polarization.** A property of light in which the planes of vibration of the (electric field of the) light are at least partially aligned.

**Pulsar.** A rotating neutron star which generates regular pulses of radiation.

**Quantum Mechanics.** The well-tested theory of the behavior of matter on the microscopic scales of atoms and computer chips, where light waves and particles share common properties.

**Quasar.** Enormously bright objects at the edge of our Universe that emit massive amounts of energy and are likely powered by black holes.

**Redshift.** An apparent shift toward longer wavelengths of spectral lines in the radiation emitted by an object caused by motion of the emitting object away from the observer.

**Singularity.** A place where spacetime becomes so strongly curved that the laws of Einstein's general relativity break down and quantum gravity must take over. Found inside black holes and perhaps at the beginning of the Big Bang.

**Spectroscopy.** The study of spectral lines (light given off at a specific frequency by an atom or molecule) from different atoms or molecules that can indicate the chemical composition of stars, gas, or dust.



**String Theory.** A theory that what we perceive as particles are actually vibrations on strings or membranes in a 10- or 11-dimensional space, respectively. These theories resolve the incompatibility between general relativity and quantum mechanics and unify them.

**z.** The symbol for the amount of redshift. The ratio of the observed change in wavelength of light emitted by a moving object to the rest wavelength of the emitted light. The most distant known galaxies and quasars have values of  $z = 6$  or greater.



## *Appendix D. Sources of Further Information*

- NASA Office of Space Science  
<http://spacescience.nasa.gov/>
- Structure and Evolution of the Universe Theme  
<http://universe.gsfc.nasa.gov/>
- Laser Interferometer Space Antenna (LISA)  
<http://lisa.jpl.nasa.gov/>
- Constellation-X  
<http://constellation.gsfc.nasa.gov/>
- Space Technology 7  
<http://nmp.jpl.nasa.gov/st7/>
- Astro-E2  
<http://astroe.gsfc.nasa.gov/docs/astroe/astroegof.html>
- High Energy Physics  
<http://doe-hep.hep.net/>  
[http://doe-hep.hep.net/HEPAP/lrp\\_report0102.pdf](http://doe-hep.hep.net/HEPAP/lrp_report0102.pdf)
- Laboratory Astrophysics  
<http://web99.arc.nasa.gov/~astrochem/nasalaw/whitepaper.html>
- Chandra X-ray Observatory  
<http://chandra.harvard.edu/>
- Rossi X-ray Timing Explorer (RXTE)  
[http://heasarc.gsfc.nasa.gov/docs/xte/xte\\_1st.html](http://heasarc.gsfc.nasa.gov/docs/xte/xte_1st.html)
- Microwave Anisotropy Probe (MAP)  
<http://map.gsfc.nasa.gov/>
- Gamma-ray Large Area Space Telescope (GLAST)  
<http://glast.gsfc.nasa.gov/>
- Gravity-Probe B  
<http://einstein.stanford.edu/>
- Swift  
<http://swift.gsfc.nasa.gov/>
- Planck  
<http://sci.esa.int/home/planck/>



## *Appendix E. Contributors to the Roadmap*

*"The effort to understand the Universe is one of the very few things that lifts human life a little above the level of farce, and gives it some of the grace of tragedy."  
—Steven Weinberg  
[Nobel Prize, 1979]*

### *The SEU Roadmap Team*

E. Sterl Phinney—Chair	California Institute of Technology
Joel N. Bregman	University of Michigan
Sean Carroll	University of Chicago
Sarah Church	Stanford University
Lynn R. Cominsky	Sonoma State University
Charles D. Dermer	Naval Research Lab
Kathryn Flanagan	Massachusetts Institute of Technology
Wendy Freedman	Carnegie Observatories
Roy R. Gould	Harvard-Smithsonian Center for Astrophysics
Timothy Heckman	Johns Hopkins University
Craig J. Hogan	University of Washington
Steven M. Kahn	Columbia University
Rocky Kolb (SEUS Chair)	Fermilab
Dan Lester	University of Texas
Robert March	University of Wisconsin
Michael Shull	University of Colorado
Simon Swordy	University of Chicago
Nicholas White	NASA/Goddard Space Flight Center
Harold W. Yorke	NASA/Jet Propulsion Laboratory

### *Ex-Officio Members*

Paul Hertz (SEU Theme Scientist)	NASA HQ
Paul DeMinco	NASA/Goddard Space Flight Center
Michael Salamon	NASA HQ
Chris Schwartz	NASA/Goddard Space Flight Center

### *Technology Subgroup*

Steven M. Kahn—Chair	Columbia University
Jamie Bock	NASA/Jet Propulsion Laboratory
Dan McCammon	University of Wisconsin
Michael Moore	NASA HQ
Harvey Moseley	NASA/Goddard Space Flight Center
Steve O'Dell	NASA/Marshall Space Flight Center
Chris Schwartz	NASA/Goddard Space Flight Center
Phil Stahl	NASA/Marshall Space Flight Center
Simon Swordy	University of Chicago

***Education/Public Outreach Subgroup***

Roy R. Gould—Chair	Harvard-Smithsonian Center for Astrophysics
Lynn R. Cominsky	Sonoma State University
James Lochner	NASA/Goddard Space Flight Center

***Research & Analysis Subgroup***

Kathryn Flanagan—Chair	Massachusetts Institute of Technology
Chris Blades	Space Telescope Science Institute
Edward Cheng	NASA/Goddard Space Flight Center
Brenda Dingus	University of Wisconsin
Wilton Sanders	University of Wisconsin
Ted Snow	University of Colorado
Robin T. Stebbins	NASA/Goddard Space Flight Center
Erick Young	University of Arizona

***Roadmap Support***

Mary Pat Hrybyk-Keith	NASA/Goddard Space Flight Center
Patricia Tyler	NASA/Goddard Space Flight Center
Christopher Wanjek	NASA/Goddard Space Flight Center



## BEYOND EINSTEIN:

How did the Universe begin?

Does time have a beginning and an end?

Does space have edges?

The questions are as old as human curiosity.

The answers have always seemed beyond the reach of science.

**UNTIL NOW.**



National Aeronautics and  
Space Administration

January 2003